

CELLULAR SHADES COLLECTION

Cellular Shades / Odysee™ Cellular Blinds



Manufacturer's Price List and Reference Guide | *Effective February 1, 2019*

MDS Midwest
WINDOW FASHIONS Designer
Supply

888-523-2611



Comfortex
WINDOW FASHIONS

Comfortex Cellular, Prelude Shades and Cellular Blinds Price List and Reference Guide | Effective February 1, 2019

This price list and reference guide contains product pricing, product specifications and technical information for the complete line of Comfortex Cellular, Prelude Shades and Odysee Cellular Blinds.

Cellular and Prelude Shades Overview	Page
Key Features/Hardware Options	1-2
Fabric Collections	3
Size Standards	4-6
Product Options Availability	7
Shade Stack Heights	8-9
Pricing Examples	10
Upgrade Options/Surcharges.	10

Rectangular

Light Filtering: Boutique 3/4", Linen Weave 3/4" and Verona 3/4"	Price Group 1	11
Room Darkening: Boutique 3/4", Linen Weave 3/4" and Verona 3/4"	Price Group 2	12
Premiere 1/2" Light Filtering	Price Group 3	13
Premiere 1/2" Blackout	Price Group 4	14
Premiere 3/4" Light Filtering	Price Group 5	15
Premiere 3/4" Blackout	Price Group 6	16
Debut 1/2" Single Light Filtering	Price Group 7	17
Debut 3/4" Light Filtering	Price Group 8	18
Debut 1/2" Double Light Filtering	Price Group 8	18
Symphony 3/8" Light Filtering	Price Group 9	19
Symphony 3/8" Blackout	Price Group 10	20
Prelude 3/4" Light Filtering	Price Group 11	21
Prelude 3/4" Blackout.	Price Group 12	22

Ovation Cellular Sliders

Size Standards - Ovation Cellular Slider Shades	23	
Ovation Cellular Slider Shades Light Filtering	Price Group 13	24
Prelude Ovation Cellular Slider Shades Light Filtering	Price Group 14	24
Ovation Cellular Slider Shades Room Darkening	Price Group 15	25
Prelude Ovation Cellular Slider Shades Blackout	Price Group 16	25

Specialty Shaped Shades

Starburst™ Arches and Quarter Rounds

Size Standards - Specialty Shaped Shades	26-27	
Boutique 3/4" Light Filtering, Debut 1/2" Single Light Filtering, Debut 1/2" Double Light Filtering, Debut 3/4" Light Filtering, Linen Weave 3/4" Light Filtering, Premiere 1/2" Light Filtering, Premiere 3/4" Light Filtering, Symphony 3/8" Light Filtering and Flame Resistant, and Verona 3/4" Light Filtering	Price Group 17	28
Prelude 3/4" Light Filtering	Price Group 18	28
Boutique 3/4" Room Darkening, Linen Weave 3/4" Room Darkening, Premiere 1/2" Blackout, Premiere 3/4" Blackout, Symphony 3/8" Blackout and Verona 3/4" Room Darkening	Price Group 19	29
Prelude 3/4" Blackout	Price Group 20	29

Sunset™ Arches

Verona 3/4" Light Filtering, Boutique 3/4" Light Filtering, Debut 1/2" Single Light Filtering, Debut 3/4" Light Filtering, Debut 1/2" Double Light Filtering, Linen Weave 3/4" Light Filtering, Premiere 1/2" Light Filtering, Premiere 3/4" Light Filtering, Symphony 3/8" Light Filtering and Flame Resistant	Price Group 21	30
--	---------------------------------	----

	Page
Prelude 3/4" Light Filtering	Price Group 22 30
Boutique 3/4" Room Darkening, Linen Weave 3/4" Room Darkening, Premiere 1/2" Blackout, Premiere 3/4" Blackout, Symphony 3/8" Blackout and Verona 3/4" Room Darkening	Price Group 23 31
Prelude 3/4" Blackout	Price Group 24 31
 Trapezoids and Octagons	
Boutique 3/4" Light Filtering, Debut 1/2" Single Light Filtering, Debut 1/2" Double Light Filtering, Debut 3/4" Light Filtering, Linen Weave 3/4" Light Filtering, Premiere 1/2" Light Filtering, Premiere 3/4" Light Filtering, Symphony 3/8" Light Filtering and Flame Resistant, Verona 3/4" Light Filtering	Price Group 25 32
Prelude 3/4" Light Filtering	Price Group 26 32
Boutique 3/4" Room Darkening, Linen Weave 3/4" Room Darkening, Premiere 1/2" Blackout, Premiere 3/4" Blackout, Symphony 3/8" Blackout and Verona 3/4" Room Darkening	Price Group 27 33
Prelude 3/4" Blackout	Price Group 28 33
 Soprano® Skylights and Greenhouse Shades	
Size Standards - Skylight and Greenhouse Shades	34
Debut 1/2" Light Filtering, Symphony 3/8" Light Filtering and Flame Resistant . . .	Price Group 29 35
 Balcony™ Shading System	
Debut 1/2" Light Filtering, Symphony 3/8" Light Filtering and Flame Resistant.	Price Group 30 36
Symphony 3/8" Blackout	Price Group 31 37
 Mezzo Motorized Skylight Shading System	
Boutique 3/4" Light Filtering, Debut 1/2" Single Light Filtering, Debut 3/4" Light Filtering, Debut 1/2" Double Light Filtering, Linen Weave 3/4" Light Filtering, Premiere 1/2" Light Filtering, Premiere 3/4" Light Filtering, Symphony 3/8" Light Filtering and Flame Resistant, and Verona 3/4" Light Filtering	Price Group 32 38
Boutique 3/4" Room Darkening, Linen Weave 3/4" Room Darkening, Premiere 1/2" Blackout, Premiere 3/4" Blackout, Symphony 3/8" Blackout, and Verona 3/4" Room Darkening	Price Group 33 39
 Prelude Skylight Shading System	
Prelude 3/4" Light Filtering	Price Group 34 40
Prelude 3/4" Blackout	Price Group 35 40
 French Door Décor	
Size Standards - Door Decor Hardware Shades	41
Non-Movable	
Boutique 3/4" Light Filtering, Debut 1/2" Single Light Filtering, Linen Weave 3/4" Light Filtering, Premiere 1/2" Light Filtering, Symphony 3/8" Light Filtering and Flame Resistant, and Verona 3/4" Light Filtering	Price Group 36 42
Movable	
Debut 1/2" Single Light Filtering, Premiere 1/2" Light Filtering, Symphony 3/8" Light Filtering and Flame Resistant	Price Group 37 43
Non-Movable	
Boutique 3/4" Room Darkening, Linen Weave 3/4" Room Darkening, Premiere 1/2" Blackout, Symphony 3/8" Blackout and Verona 3/4" Blackout	Price Group 38 44







	Page
Movable	
Premiere 1/2" Blackout and Symphony 3/8" Blackout	Price Group 39 45
Hardware - All fabrics except Prelude	
Standard and Deluxe Cord Lock Shades	46-47
Cord Loop Hardware System	48-49
Cordless Ultra Hardware System	50-51
Cordless Lift & Lock	52-53
Rechargeable Simplicity Motorized Cellular Shades	54-56
NEW Motorized Top Down-Bottom Up Shades	57-58
Simplicity Smart Controller	59
Rechargeable PowerTouch Motorized Cellular Shades	60-61
Ovation Cellular Slider	62-63
Insulating SlumberShades	64-65
Starburst Arches	66
Sunset Arches	67-68
Quarter Rounds	69-70
Trapezoids and Octagons	71-72
Soprano Skylights and Greenhouse Shades	73-74
Balcony Shading System	75-76
Mezzo Motorized Skylight Shading System	77-79
Door Decor	80-81
Day - Night Shades	82-83
Custom Graphics	
Custom Graphics	84
Hardware - Prelude	
Prelude Standard Cord Lock Shades	85-86
Prelude Cord Loop Hardware System	87-88
Prelude Cordless Ultra Hardware System	89-90
Prelude Cordless Lift & Lock	91-92
Prelude Rechargeable Simplicity Motorized Cellular Shades	93-95
Prelude Rechargeable PowerTouch Motorized Cellular Shades	96-97
Prelude Ovation Cellular Slider	98-99
Prelude Starburst Arches	100
Prelude Sunset Arches	101-102
Prelude Quarter Rounds	103
Prelude Trapezoids and Octagons	104-105
Prelude Skylight Shading System	106
Cellular Shades General Information	
Highlights Cornice Valances	107
Fabric Characteristics	107
Cut-Outs	107
Odysee Cellular Blinds	
Key Features/Hardware Options	108
Pricing Examples	109
Odysee Light Filtering	Price Group 40 109
Odysee Hardware	110
Operating Cords	111
Stack Heights	111
Odysee Vane Characteristics	111
Cordless PowerTouch Push Button Control	112
Rechargeable Motorized Odysee Cellular Blinds	113-114
Operating Odysee Blinds	115
Odysee Certified Fabrics	115

Measuring Instructions for Odysee Cellular Blinds 118
Cleaning and Care of Odysee Cellular Blinds 117

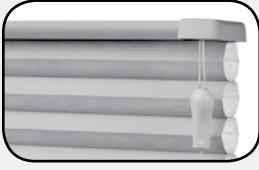
General Information

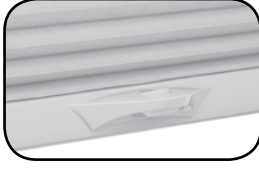

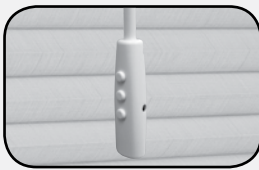

Scotchgard Protection 116
Certified Fabrics 116
Symphony Flame Resistant Fabrics 116
EZ Level 116
Cleaning and Care 117
Measuring Instructions 118
Measuring Specialty Shades 118
Making the Perfect Template 119
Conditions Of Sale 120
Policies 120
Freight Policy 120
Child Safety 121
Cellular Shades and Odysee Cellular Blinds Warranty Information 122
Motorized Shades Warranty 122
Scotchgard™ Warranty 123

Cellular Shade Collection
HARDWARE OPTIONS

	Key Features	Color Options	Hardware Size (Depth x Height)	Widths & Lengths*	More Information
<p>Cord Lock</p> 	<ul style="list-style-type: none"> Reliable cord lock Sleek, color coordinated rails UV resistant materials 	<ul style="list-style-type: none"> Color Coordinated Fabric Wrapped Brushed Nickel Oil Rubbed Bronze 	<p>Standard Head Rail: 1 7/8" x 1/2"</p> <p>Deluxe Head Rail: 2 3/8" x 1/2"</p>	<p>Width: 8" up to 144"</p> <p>Length: 8" up to 120"</p>	<p>Page 46</p>
<p>Cord Loop</p> 	<ul style="list-style-type: none"> Great for large windows Smooth & quiet operation 	<ul style="list-style-type: none"> Color Coordinated Fabric Wrapped Brushed Nickel Oil Rubbed Bronze 	<p>2 1/4" x 1 1/2"</p>	<p>Width: 14" up to 144"</p> <p>Length: 8" up to 120"</p>	<p>Page 48</p>
<p>Cordless Ultra</p> 	<ul style="list-style-type: none"> Child safe No visible cords Smooth & quiet operation Sleek clear handle on rails Two-On-One option available 	<ul style="list-style-type: none"> Color Coordinated Fabric Wrapped Brushed Nickel Oil Rubbed Bronze 	<p>2 1/4" x 1 1/2"</p>	<p>Width: 18" up to 144"</p> <p>Length: 8" up to 84"</p>	<p>Page 50</p>
<p>Cordless Lift & Lock</p> 	<ul style="list-style-type: none"> Child safe Easy push button operation Rails lock securely in place in any position Color coordinated rails and handle 	<ul style="list-style-type: none"> Color Coordinated Fabric Wrapped Oil Rubbed Bronze 	<p>Standard Head Rail: 1 7/8" x 1/2"</p> <p>Deluxe Head Rail: 2 3/8" x 1/2"</p> <p>Bottom Rail: 1 7/8" x 1 1/8"</p>	<p>Width: 16" up to 96"</p> <p>Length: 8" up to 84"</p>	<p>Page 52</p>
<p>Simplicity Rechargeable Motorization</p> 	<ul style="list-style-type: none"> Raise & lower shade with click of a button Great for large and hard to reach windows Remote can operate multiple shades Standard or Top Down-Bottom Up 	<ul style="list-style-type: none"> Color Coordinated Fabric Wrapped Oil Rubbed Bronze Brushed Nickel 	<p>2 1/4" x 1 1/2"</p>	<p>Width: 18" up to 144"</p> <p>Length: 8" up to 120"</p>	<p>Page 54</p>
<p>PowerTouch™ Rechargeable Cordless Wand</p> 	<ul style="list-style-type: none"> Raise & lower shade with push of a button Just "Touch & Go" to operate the shade Set your favorite shade position Easy access to charging port on side of pendant 	<ul style="list-style-type: none"> Wand and pendant available in white or black 	<p>2 1/4" x 1 1/2"</p>	<p>Width: 18" up to 144"</p> <p>Length: 8" up to 120"</p>	<p>Page 60</p>
<p>Ovation™ Slider</p> 	<ul style="list-style-type: none"> Vertically oriented fabric glides across window Shade can stack left, right or center Great for sliding glass doors or room dividers 	<ul style="list-style-type: none"> White (Standard) Ivory Beige Tan Gray 	<p>3 5/8" x 1 3/4"</p>	<p>Width: 12" up to 168"</p> <p>Length: 24" up to 120"</p>	<p>Page 62</p>

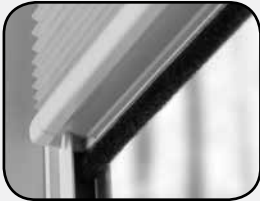
* Maximum widths and lengths listed do not take into account square foot or weight limitations. Make sure to refer to shaded areas on price groups for maximum size availability by fabric style.

Cellular Shade Collection
HARDWARE OPTIONS

	Key Features	Color Options	Hardware Size (Depth x Height)	Widths & Lengths*	More Information
<p>French Door Décor</p> 	<ul style="list-style-type: none"> • Great option for narrow windows and doors • Available in moveable & non-moveable rails • No Pull cords 	<ul style="list-style-type: none"> • Color Coordinated • Fabric Wrapped • Brushed Nickel • Oil Rubbed Bronze 	<p>Standard Head Rail: 1 7/8" x 1/2"</p> <p>Deluxe Head Rail: 2 3/8" x 1/2"</p>	<p>Width: 6" up to 36"</p> <p>Length: 12" up to 96"</p>	<p>Page 80</p>
<p>Insulating SlumberShade™</p> 	<ul style="list-style-type: none"> • Ultimate blackout shade • Tracks keep out light, cold or heat • Perfect for nurseries, day sleepers 	<ul style="list-style-type: none"> • Color Coordinated • Fabric Wrapped • Brushed Nickel • Oil Rubbed Bronze • Sidetracks are available in white, tan or Bronze 	<p>Dependant on hardware choice</p>	<p>Width: 9" up to 96"</p> <p>Length: 8" up to 120"</p>	<p>Page 64</p>
<p>Top Down-Bottom Up</p> 	<ul style="list-style-type: none"> • Lower shade from top: raise from bottom • Great for privacy • Ideal for light control • Available in Cord Lock, Cord Loop, Cordless and motorized 	<ul style="list-style-type: none"> • Color Coordinated • Fabric Wrapped • Oil Rubbed Bronze • Brushed Nickel 	<p>Dependant on hardware choice</p>	<p>Width: 18" up to 120"</p> <p>Length: 8" up to 120"</p>	<p>See Product Availability Page 7-8</p>
<p>Two on One Head Rail</p> 	<ul style="list-style-type: none"> • Operate two shades on one rail • Great for larger windows • Individually operating shades 	<ul style="list-style-type: none"> • Color Coordinated • Fabric Wrapped • Oil Rubbed Bronze • Brushed Nickel 	<p>Dependent on Style See Above</p>	<p>Width: 16" up to 144"</p> <p>Length: 8" up to 120"</p>	<p>See Product Availability Page 7-8</p>
<p>Highlights Cornice Valance</p> 	<ul style="list-style-type: none"> • Adds height to windows • Available as inside and outside mount • Easy to install 	<ul style="list-style-type: none"> • 100+ Envision fabrics • 100s of patterns and colors 	<p>Width: 24" x 216"</p> <p>Valance Height: 6"</p> <p>Returns: 1 1/2" x 6"</p>	<p>Varies by selected fabric</p> <p>Width: 12" up to 216"</p>	<p>Page 107</p>

* Maximum widths and lengths listed do not take into account square foot or weight limitations. Make sure to refer to shaded areas on price groups for maximum size availability by fabric style.

Make sure to consult specification charts for specific fabric styles.

Cellular Shade Collection
FABRIC COLLECTIONS

Fabric Collection	Cell Size and Structure	Opacities	Fabric Content
Boutique	<ul style="list-style-type: none"> • ¾ -Inch • Single Cell 	<ul style="list-style-type: none"> • Light Filtering • Karma-Light Room Darkening 	<ul style="list-style-type: none"> • Light Filtering: Non-Woven Polyester • Room Darkening: Opaque lining pressed between two layers of non-woven polyester • Karma-Light technology insures color on front fabric will not be distorted like traditional blackout shades. Opaque lining is used only on back side of the cells
Debut*	<ul style="list-style-type: none"> • ½-Inch Single Cell • ¾-Inch Single Cell • ½-Inch Double Cell 	<ul style="list-style-type: none"> • Light Filtering 	<ul style="list-style-type: none"> • Light Filtering: Non-Woven Polyester
Linen Weave	<ul style="list-style-type: none"> • ¾ -Inch • Single Cell 	<ul style="list-style-type: none"> • Light Filtering • Karma-Light Room Darkening 	<ul style="list-style-type: none"> • Light Filtering: Non-Woven Polyester • Karma-Light technology insures color on front fabric will not be distorted like traditional blackout shades.
Premiere**	<ul style="list-style-type: none"> • ½-Inch • ¾-Inch • Single Cell 	<ul style="list-style-type: none"> • Light Filtering • Blackout • Karma-Light Room Darkening 	<ul style="list-style-type: none"> • Light Filtering: Non-Woven Polyester • Blackout: Opaque lining pressed between two layers of non-woven polyester • Karma-Light technology insures color on front fabric will not be distorted like traditional blackout shades. Opaque lining is used only on back side of the cells • Limited Blackout colors available, refer to www.comfortex.com
Symphony	<ul style="list-style-type: none"> • ¾-Inch • Double Cell 	<ul style="list-style-type: none"> • Light Filtering • Flame Retardant Light Filtering • Blackout 	<ul style="list-style-type: none"> • Light Filtering: Non-Woven Polyester • Blackout: Non-Woven Polyester with foil lining
Verona	<ul style="list-style-type: none"> • ¾ Inch • Single Cell 	<ul style="list-style-type: none"> • Light Filtering • Karma-Light Room Darkening 	<ul style="list-style-type: none"> • Light Filtering: Non-Woven Polyester • Room Darkening: Opaque lining pressed between two layers of non-woven polyester • Karma-Light technology insures color on front fabric will not be distorted like traditional blackout shades. Opaque lining is used only on back side of the cells

* Debut Light Filtering fabrics include solid colors, Homespun, Country Woven, Florance, Strata, Angel Hair, Blossom, Strie and Terrazzo.

** Premiere fabrics include the following prints: Spheres and Tuscan Scroll. Premiere Blackout fabrics include the following prints: Homespun, Country Woven, Florance, Strata, Angel Hair and Blossom.

Cellular Shade Collection
SIZE STANDARDS

CELLULAR SHADE COLLECTION

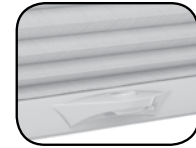
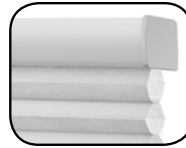
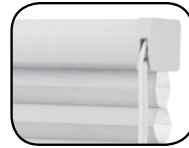
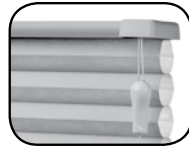

	Minimum	Cord Lock		Cord Loop		Cordless Ultra		Cordless Lift & Lock	
		Bottom Up	Top Down Bottom Up	Bottom Up	Top Down Bottom Up	Bottom Up	Top Down Bottom Up	Bottom Up	Top Down Bottom Up
ALL FABRICS (except 3/4" Prelude)	Minimum Width	8"	12"	14"	22"	15" OB or 15 3/8" IB	18" OB or 18 3/8" IB	16" OB or 16 3/8" IB	20" OB or 20 3/8" IB
	Min. Length	8"	8"	8"	8"	8"	8"	8"	8"
Prelude 3/4"	Min. Width	8"	10"	18"	24"	16"	16"	12"	16" OB or 16 1/2" IB
	Min. Length	12"	12"	12"	12"	12"	12"	12"	12"

Light Filtering	Price Group	Page		Cord Lock		Cord Loop		Cordless Ultra		Cordless Lift & Lock	
				Bottom Up	Top Down Bottom Up	Bottom Up	Top Down Bottom Up	Bottom Up	Top Down Bottom Up	Bottom Up	Top Down Bottom Up
Boutique 3/4"	1	11	Maximum Width & Length								
Debut	7 & 8	17-									
Premiere	3	1819									
Linen Weave 3/4"	1	11									
Symphony 3/8"	9	19									
Verona 3/4"	1	17	Refer to shaded area in price grids for max size (sq ft) by fabric style	108" width* 120" length	96" width 96" length	108" width 120" length	108" width 120" length	108" width* 84" length	96" width 84" length	96" width 84" length	96" width 84" length
Prelude 3/4"	11	27	Maximum Width & Length - Sq Ft.	60" width 120" length 50 sq ft	72" width 96" length 50 sq ft	120" width 120" length 100 sq ft	120" width 120" length 100 sq ft	120" width 84" length 70 sq ft	96" width 84" length 56 sq ft	84" width 84" length 49 sq ft	84" width 84" length 49 sq ft

Room Darkening & Blackout	Price Group	Page		Cord Lock		Cord Loop		Cordless Ultra		Cordless Lift & Lock	
				Bottom Up	Top Down Bottom Up	Bottom Up	Top Down Bottom Up	Bottom Up	Top Down Bottom Up	Bottom Up	Top Down Bottom Up
Boutique 3/4"	2	12	Maximum Width & Length								
Linen Weave 3/4"	2	12									
Premiere	4	14									
Verona 3/4"	2	12	Refer to shaded area in price grids for max size (sq ft) by fabric style	108" width* 120" length	84" width 96" length	108" width* 120" length	108" width* 120" length	108" width* 84" length	96" width* 84" length	96" width 84" length	96" width 84" length
Symphony 3/8"	10	20		120" width 120" length	84" width 96" length	120" width 120" length	120" width 120" length	Not Available		84" width 84" length	84" width 84" length
Prelude 3/4"***	12	22	Maximum Width & Length - Sq Ft.	60" width 120" length 50 sq ft	72" width 96" length 50 sq ft	120" width 120" length 100 sq ft	120" width 120" length 100 sq ft	96" width 84" length 56 sq ft	96" width 84" length 56 sq ft	84" width 84" length 49 sq ft	84" width 84" length 49 sq ft

	Cord Lock		Cord Loop		Cordless Ultra		Cordless Lift & Lock	
	Bottom Up	Top Down Bottom Up	Bottom Up	Top Down Bottom Up	Bottom Up	Top Down Bottom Up	Bottom Up	Top Down Bottom Up
Stacking Heights Information On Page More Information On Page	Page 8-9 Page 46		Page 8-9 Page 48		Page 8-9 Page 50		Page 8-9 Page 52	

Please Note: For any shades under 12" width, the maximum height is 80".

* Baritone and Virtuoso maximum width is 120"

**Maximum width for side mount refer to hardware pages.

Cellular Shade Collection
SIZE STANDARDS



	Minimum	Motorization	Motorization	Two-On-One Head Rail	
		Rechargeable Simplicity	PowerTouch Rechargeable	Cord Lock	Cord Loop/Cordless
ALL FABRICS (except 3/4" Prelude)	Minimum Width	18"	18"	16"	36"
	Min. Length	8"	8"	8"	8"
Prelude 3/4"	Min. Width	18"	18"	16"	36"
	Min. Length	12"	12"	12"	12"

Light Filtering	Price Group	Page		Motorization	Motorization	Two-On-One Head Rail	
				Rechargeable Simplicity	PowerTouch Rechargeable	Cord Lock	Cord Loop/Cordless
Boutique 3/4"	1	11	Maximum Width & Length Refer to shaded area in price grids for max size (sq ft) by fabric style	96" width 120" length**	96" width 120" length**	144" width 120" length	144" width 120" length
Debut	7 & 8	17-18					
Premiere	3	13					
Linen Weave 3/4"	1	11					
Symphony 3/8"	9	19					
Verona 3/4"	1	11					
Prelude 3/4"	11	21	Maximum Width & Length - Sq Ft.	96" width 120" length** 50 sq ft	96" width 96" length** 50 sq ft	120" width 120" length 50 sq ft	120" width 120" length 50 sq ft

Room Darkening & Blackout	Price Group	Page		Motorization	Motorization	Two-On-One Head Rail	
				Rechargeable Simplicity	PowerTouch Rechargeable	Cord Lock	Cord Loop/Cordless
Boutique 3/4"	2	12	Maximum Width & Length Refer to shaded area in price grids for max size (sq ft) by fabric style	96" width 120" length**	96" width 120" length**	144" width 120" length	144" width 120" length
Linen Weave 3/4"	2	12					
Premiere	4	14					
Verona 3/4"	2	12					
Symphony 3/8"	10	20					
Prelude 3/4"	12	22	Maximum Width & Length - Sq Ft.	96" width 120" length** 50 sq ft	96" width 96" length** 50 sq ft	120" width 120" length 50 sq ft	120" width 120" length 50 sq ft

	Motorization	Motorization	Two-On-One Head Rail	
	Rechargeable Simplicity	PowerTouch Rechargeable	Cord Lock	Cord Loop/Cordless
Stacking Heights Information On Page More Information On Page	Page 8-9 Page 54	Page 8-9 Page 60	Page 8-9 Page 7	

Please Note: For any shades under 12" width, the maximum height is 80".

* Maximum widths and lengths listed do not take into account square foot or weight limitations. Make sure to refer to shaded areas on price groups for maximum size availability by fabric style.

** Motorized shades less than 24" in width are limited to a maximum of 60" in length.

+Simplicity Rechargeable Top Down-Bottom Up motorization minimum width is 24" IB and 23 3/8" OB.

Cellular Shade Collection
SIZE STANDARDS

CELLULAR SHADE COLLECTION



		SlumberShade Cord Lock		SlumberShade Cord Loop		SlumberShade Cordless	
		Bottom Up	Top Down Bottom Up	Bottom Up	Top Down Bottom Up	Bottom Up	Top Down Bottom Up
ALL FABRICS	Minimum Width	9"	13"	15"	25"	16" IB	19"
	Min. Length	8"	8"	8"	8"	8"	8"

			SlumberShade Cord Lock		SlumberShade Cord Loop		SlumberShade Cordless	
			Bottom Up	Top Down Bottom Up	Bottom Up	Top Down Bottom Up	Bottom Up	Top Down Bottom Up
Light Filtering	Price Group	Page						
Debut	7	17	Maximum Width & Length Refer to shaded area in price grids for max size (sq ft) by fabric style	96" width 120" length	96" width 96" length	96" width 120" length	96" width 120" length	96" width 84" length
Linen Weave	1	11						
Premiere	3	13						
Symphony 3/8"	9	19						
Verona	1	11						

			SlumberShade Cord Lock		SlumberShade Cord Loop		SlumberShade Cordless	
			Bottom Up	Top Down Bottom Up	Bottom Up	Top Down Bottom Up	Bottom Up	Top Down Bottom Up
Room Darkening & Blackout	Price Group	Page						
Debut	8	18	Maximum Width & Length Refer to shaded area in price grids for max size (sq ft) by fabric style	96" width 120" length	84" width 96" length	96" width 120" length	96" width 120" length	96" width 84" length Symphony Blackout not available as cordless
Linen Weave	2	12						
Premiere	4	14						
Symphony 3/8"	10	20						
Verona	2	12						

			SlumberShade Cord Lock		SlumberShade Cord Loop		SlumberShade Cordless	
			Bottom Up	Top Down Bottom Up	Bottom Up	Top Down Bottom Up	Bottom Up	Top Down Bottom Up
Stacking Heights Information On Page More Information On Page			Page 8-9 Page 64		Page 8-9 Page 64		Page 8-9 Page 64	

Please Note: For any shades under 12" width, the maximum height is 80".

Cellular Shade Collection

HARDWARE OPTION AVAILABILITY

Use this table to ensure your coordinating options and unique shapes are consistent with your product selections.

	Verona LF & RD	Boutique LF & RD	Premiere LF & RD	Linen Weave LF & RD	Symphony Light Filtering	Symphony Blackout	Debut ½" Light Filtering	Debut ¾" Light Filtering	Debut Double Cell Light Filtering
STANDARD CORD LOCK									
Standard Cord Lock	•	•	•	•	•	•	•	•	•
Top Down-Bottom Up	•	•	•	•	•	•	•	•	•
Two-On-One Head Rail	•	•	•	•	•	•	•	•	•
Day-Night	•	•	•	•	•	•	•	•	•
CORD LOOP									
Cord Loop	•	•	•	•	•	•	•	•	•
Cord Loop Top Down-Bottom Up	•	•	•	•	•	•	•	•	•
Cord Loop Two-On-One Head Rail	•	•	•	•	•	•	•	•	•
CORDLESS ULTRA									
Cordless Ultra	•	•	•	•	•	-	•	•	•
Cordless Two-On-One Head Rail	•	•	•	•	•	•	•	•	•
Cordless Ultra Top Down-Bottom Up	•	•	•	•	•	-	•	•	•
CORDLESS LIFT & LOCK									
Cordless Lift & Lock	•	•	•	•	•	•	•	•	•
Cordless Lift & Lock Two-On-One Head Rail	•	•	•	•	•	•	•	•	•
Cordless Lift & Lock Top Down-Bottom Up	•	•	•	•	•	•	•	•	•
MOTORIZATION									
Simplicity Rechargeable Motorization	•	•	•	•	•	•	•	•	•
PowerTouch™ Rechargeable	•	•	•	•	•	•	•	•	•
Top Down-Bottom Up	•	•	•	•	•	•	•	•	•
INSULATING SLUMBERSHADES									
Cord Lock	•	-	•	•	•	•	•	•	•
Cord Lock Top Down-Bottom Up	•	-	•	•	•	•	•	•	•
Cordless Ultra	•	-	•	•	•	-	•	•	•
Cordless Ultra Top Down-Bottom Up	•	-	•	•	•	-	•	•	•
Cord Loop	•	-	•	•	•	•	•	•	•
Cord Loop Top Down-Bottom Up	•	-	•	•	•	•	•	•	•
SKYLIGHTS AND SPECIALTY SHAPES									
Balcony Shading System	-	-	-	-	•	•	•	-	-
French Door Decor	•	•	•	•	•	•	•	•	•
Mezzo Motorized Skylights	•	•	•	•	•	•	•	•	•
Octagon	•	•	•	•	•	•	•	•	•
Ovation Cellular Slider	•	•	•++	•	•	-	•	•	•
Quarter Round - Moveable	•	•	•	•	•	•	•	•	•
Quarter Round - Non-Movable	•	•	•	•	•	•	•	•	•
Soprano Skylights and Greenhouses	-	-	-	-	•	-	•	-	-
Starburst Arch - Moveable	•	•	•	•	•	•	•	•	•
Starburst Arch - Non-Movable	•	•	•	•	•	•	•	•	•
Sunset Arch - Moveable	•*	•*	•	•*	•	-	•	•	•
Trapezoid	•	•	•	•	•	•	•	•	•

* Light Filtering Fabric Only
++ ¾" Premiere fabrics only

Cellular Shade Collection

SHADE STACK HEIGHTS

Measurements are in inches. Shade stacking heights applicable when the shade is in the fully raised position.

RECTANGULAR CORD LOCK - Includes head and bottom rails	48"	72"	84"	96"	108"	120"
Verona	2"	2 ³ / ₈ "	2 ⁵ / ₈ "	2 ⁷ / ₈ "	3 ¹ / ₈ "	3 ³ / ₈ "
Boutique	2"	2 ³ / ₈ "	2 ⁵ / ₈ "	2 ⁷ / ₈ "	3 ¹ / ₈ "	3 ³ / ₈ "
Debut 1/2" Double Cell Light Filtering	1 1/2"	1 1/8"	1 1/4"	1 7/8"	2"	2 1/8"
Debut 1/2" Single Cell Light Filtering	3 1/4"	2 3/4"	3"	3 3/8"	3 3/8"	4"
Debut 3/4" Single Cell Light Filtering	1 1/2"	1 3/8"	1 3/4"	1 7/8"	2"	2 1/8"
Linen Weave (All)	2"	2 ³ / ₈ "	2 ⁵ / ₈ "	2 ⁷ / ₈ "	3 ¹ / ₈ "	3 ³ / ₈ "
Premiere 1/2" Single Cell Blackout	2"	2 1/2"	2 ⁵ / ₈ "	2 ⁷ / ₈ "	3 ¹ / ₈ "	3 1/4"
Premiere 1/2" Single Cell Light Filtering	1 7/8"	2 1/4"	2 1/2"	2 ⁵ / ₈ "	2 ⁷ / ₈ "	3"
Premiere 3/4" Single Cell Blackout	2"	2 ³ / ₈ "	2 ⁵ / ₈ "	2 3/4"	3"	3 1/8"
Premiere 3/4" Single Cell Light Filtering	1 3/4"	2 1/8"	2 1/4"	2 3/8"	2 1/2"	2 5/8"
Symphony 3/8" Double Cell Blackout	2"	2 1/2"	2 3/4"	3"	3 1/4"	3 1/2"
Symphony 3/8" Double Cell Light Filtering	2 1/4"	2 3/4"	3"	3 1/4"	3 1/2"	3 3/4"

For Top Down-Bottom Up, add 3/8"

CORD LOOP - CORDLESS ULTRA - MOTORIZATION - Includes head and bottom rails	48"	72"	84"	96"	108"	120"
Verona	3"	3 3/8"	3 5/8"	3 7/8"	4 1/8"	4 3/8"
Boutique	3"	3 3/8"	3 5/8"	3 7/8"	4 1/8"	4 3/8"
Debut 1/2" Double Cell Light Filtering	2 1/2"	2 5/8"	2 3/4"	2 7/8"	3"	3 1/8"
Debut 1/2" Single Cell Light Filtering	3 1/4"	3 3/4"	4"	4 3/8"	4 5/8"	5"
Debut 3/4" Single Cell Light Filtering	2 1/2"	2 5/8"	2 3/4"	2 7/8"	3"	3 1/8"
Linen Weave (All)	3"	3 3/8"	3 5/8"	3 7/8"	4 1/8"	4 3/8"
Premiere 1/2" Single Cell Blackout	3"	3 1/2"	3 5/8"	3 7/8"	4 1/8"	4 1/4"
Premiere 1/2" Single Cell Light Filtering	2 7/8"	3 1/4"	3 1/2"	3 5/8"	3 7/8"	4"
Premiere 3/4" Single Cell Blackout	3"	3 3/8"	3 5/8"	3 3/4"	4"	4 1/8"
Premiere 3/4" Single Cell Light Filtering	2 3/4"	3 1/8"	3 1/4"	3 3/8"	3 1/2"	3 5/8"
Symphony 3/8" Double Cell Blackout	2 7/8"	3 3/8"	3 5/8"	3 7/8"	4 1/2"	4 3/4"
Symphony 3/8" Double Cell Light Filtering	3 1/8"	3 1/2"	3 3/4"	3 7/8"	4 1/8"	4 1/4"

For Top Down-Bottom Up, add 5/8"

CORDLESS LIFT & LOCK - Includes head and bottom rails	48"	60"	72"	84"	108"	120"
Verona	2 3/4"	3 1/8"	3 3/8"	3 5/8"	3 7/8"	4 1/8"
Boutique	2 3/4"	3 1/8"	3 3/8"	3 5/8"	3 7/8"	4 1/8"
Debut 1/2" Double Cell Light Filtering	2 1/4"	2 3/8"	2 1/2"	2 5/8"	2 3/4"	2 7/8"
Debut 1/2" Single Cell Light Filtering	3"	3 1/2"	3 3/4"	4 1/8"	4 3/8"	4 3/4"
Debut 3/4" Single Cell Light Filtering	2 1/4"	2 3/8"	2 1/2"	2 5/8"	2 3/4"	2 7/8"
Linen Weave (All)	2 3/4"	3 1/8"	3 3/8"	3 5/8"	3 7/8"	4 1/8"
Premiere 1/2" Single Cell Blackout	2 3/4"	3 1/4"	3 3/8"	3 5/8"	3 7/8"	4"
Premiere 1/2" Single Cell Light Filtering	2 5/8"	3 3/4"	3 1/4"	3 3/8"	3 1/2"	3 1/2"
Premiere 3/4" Single Cell Blackout	2 3/4"	3 1/8"	3 3/8"	3 1/2"	3 3/4"	3 3/8"
Premiere 3/4" Single Cell Light Filtering	2 1/4"	2 7/8"	3"	3 1/8"	3 3/8"	3 1/2"
Symphony 3/8" Double Cell Blackout	2 3/4"	3 1/4"	3 1/2"	NA	NA	NA
Symphony 3/8" Double Cell Light Filtering	3"	3 1/2"	3 3/4"	4"	4 1/4"	4 1/2"

For Top Down-Bottom Up, add 1 1/4"

OVATION	84"	96"	108"	120"
All Fabrics	6 1/2"	7 1/4"	8"	8 3/4"

Ovations minimum fabric stack measures 6 1/2" regardless of the ordered width. Fabric stacking dimensions are determined by the slider's hardware, not ordered width.

Prelude Shade

SHADE STACK HEIGHTS

Measurements are in inches. Shade stacking heights applicable when the shade is in the fully raised position.

RECTANGULAR CORD LOCK - Includes head and bottom rails	48"	72"	84"	96"	108"	120"
Prelude Light Filtering	2"	2 ³ / ₈ "	2 ⁵ / ₈ "	2 ⁷ / ₈ "	3 ¹ / ₈ "	3 ³ / ₈ "
Prelude Blackout	1 ¹ / ₂ "	1 ³ / ₄ "	1 ⁷ / ₈ "	2"	2 ¹ / ₈ "	2 ¹ / ₄ "

For Top Down-Bottom Up, add ⁵/₈"

CORD LOOP - CORDLESS ULTRA - MOTORIZATION - Includes head and bottom rails	48"	72"	84"	96"	108"	120"
Prelude Light Filtering	3"	3 ³ / ₈ "	3 ⁵ / ₈ "	3 ⁷ / ₈ "	4 ¹ / ₈ "	4 ³ / ₈ "
Prelude Blackout	2 ¹ / ₄ "	2 ¹ / ₂ "	2 ⁵ / ₈ "	2 ³ / ₄ "	2 ⁷ / ₈ "	3"

For Top Down-Bottom Up, add ⁵/₈"

CORDLESS LIFT & LOCK - Includes head and bottom rails	48"	60"	72"	84"	108"	120"
Prelude Light Filtering	2 ³ / ₄ "	3 ¹ / ₈ "	3 ³ / ₈ "	3 ⁵ / ₈ "	3 ⁷ / ₈ "	4 ¹ / ₈ "
Prelude Blackout	2 ¹ / ₄ "	2 ¹ / ₂ "	2 ⁵ / ₈ "	2 ³ / ₄ "	2 ⁷ / ₈ "	3"

For Top Down-Bottom Up, add 1¹/₄"

OVATION	84"	96"	108"	120"
Prelude	6 ¹ / ₂ "	7 ¹ / ₄ "	8"	8 ³ / ₄ "

Ovations minimum fabric stack measures 6¹/₂" regardless of the ordered width. Fabric stacking dimensions are determined by the slider's hardware, not ordered width.

Cellular Shade Collection
HARDWARE UPGRADE OPTIONS

LIFT SYSTEM	UPGRADES	ADD
Cord Lock	Top Down-Bottom Up	\$68
Cordless Lift & Lock	Bottom Up	No extra charge
	Top Down-Bottom Up	\$88
Cordless Ultra	Bottom Up	\$88
	Top Down-Bottom Up	\$175
Cord Loop	Bottom Up	\$88
	Top Down-Bottom Up	\$175

DESIGNER UPGRADE OPTIONS	UPGRADES	ADD
Add to Any Lift System Upgrade <i>(Chart to the left)</i>	Metallic Hardware	\$24
	Fabric Wrapped Hardware	\$24
	Scotchgard Stain Protection	\$38
	Highlights Valance <i>See Page 107 For More Information</i>	
Light Blocking Sidetrack System	Insulating SlumberShades <i>See Page 64 For More Information</i>	\$142

ADDITIONAL OPTIONS	UPGRADES	ADD
Add to Any Upgrade Above	Two-On-One Head Rail	\$52 Add to Cord Lock Shade and add lift system upgrade
	Three-On-One Head Rail	\$105 Add to Cord Lock Shade and add lift system upgrade (Prelude Only)
	Cut Outs	\$55 Per side
	Day-Night	Price each separate shade then add together
Other	Soprano - Two Moving Rails	\$136
	Ovation Center Stack	\$88
Accessories	6 Foot Expandable Pole	\$44
	12 Foot Expandable Pole	\$54

Cellular Shade Motorized Hardware Upgrade Options

MOTORIZED	UPGRADES	ADD	
PowerTouch Rechargeable Motorization System	Rechargeable Integrated Battery Pack	\$132	For More Information Page 60
	Plug-In Charger for Rechargeable Li-Ion	\$30	
Simplicity Rechargeable Motorization System	Motor with Integrated Li-Ion Battery	\$368	For More Information Page 54
	Simplicity 5 Channel Remote	\$44	
	Simplicity 6 Channel Remote/Timer	\$72	
	Plug-In Charger for Rechargeable Li-Ion	\$30	
	Top Down-Bottom Up*	\$589	
	Top Down-Bottom Up 14 Channel Remote**	\$72	
Simplicity Smart Controller System	7.4v Solar Panel & Mounting Brackets	\$110	For More Information Page 59
	NEO Controller	\$363	
	NEO Application for Mobile Devices	FREE	

*Upcharge includes motorization plus second motor and Top Down-Bottom Up components

** TDBU Remote required for Motorized Top Down-Bottom Up shades

Cellular Shade Pricing Examples

Rechargeable Simplicity Pricing Example:

Linen Weave	
Light Filtering 42" x 60" Shade:	\$383.00
Simplicity Rechargeable Motor Surcharge:	\$368.00
Charger for Rechargeable:	\$30.00
Simplicity Remote Control:	\$44.00
Total List Price:	\$825.00

Motorized Top Down-Bottom Up Pricing Example:

Linen Weave	
Light Filtering 42" x 60" Shade:	\$383.00
Simplicity Rechargeable TDBU Surcharge:	\$589.00
Charger for Rechargeable:	\$30.00
TDBU Remote Control:	\$72.00
Total List Price:	\$1074.00

Cellular Shade Collection
PRICING

Boutique 3/4" Light Filtering
Linen Weave 3/4" Light Filtering
Verona 3/4" Light Filtering

PRICE GROUP 1
Cord Lock
Cordless Lift & Lock

		Width In Inches														
		24	30	36	42	48	54	60	66	72	84	96	108	120	132	144
Length In Inches	36	199	222	255	284	314	342	371	396	426	490	551	612	677	738	800
	42	213	244	273	309	342	373	408	438	471	541	609	679	754	829	905
	48	225	261	299	334	371	406	441	480	516	603	689	775	862	948	1034
	54	242	277	318	357	398	437	485	533	582	679	775	872	969	1066	1163
	60	257	297	342	383	425	485	539	592	646	754	861	969	1077	1185	1292
	66	269	314	363	415	474	533	592	652	711	829	948	1066	1185	1303	1421
	72	284	329	383	453	517	582	646	711	775	905	1034	1163	1292	1421	1550
	78	299	351	420	490	560	630	700	770	840	980	1120	1260	1400	1539	1679
	84	308	377	453	528	603	679	754	829	905	1055	1206	1357	1507	1657	1808
	90	322	404	485	566	646	727	808	888	969	1131	1292	1453	1614	1776	1937
	96	345	431	517	603	689	775	861	948	1034	1206	1378	1549	1722	1894	2066
	108	388	485	582	679	775	872	969	1066	1163	1357	1549	1743	1937	2131	2325
120	431	539	646	754	861	969	1077	1184	1292	1506	1721	1937	2152	2368	2583	

Cord Loop Hardware is recommended on sizes within the shaded area.
Motorized Lift Systems are not offered within the shaded area.

Widths over 108" will be built as Two-On-One Shades.

STANDARD RECTANGULAR

LIFT SYSTEM AND DESIGN UPGRADES		ADD	
Cord Lock	Top Down-Bottom Up	\$68	
Cordless Lift & Lock	Bottom Up	No Charge	
	Top Down-Bottom Up	\$88	
Cordless Ultra	Bottom Up	\$88	
	Top Down-Bottom Up	\$175	
Cord Loop	Bottom Up	\$88	
	Top Down-Bottom Up	\$175	
DESIGNER UPGRADE OPTIONS (Add to any Lift System Upgrade Above)		ADD	
Metallic Hardware or Fabric Wrapped Hardware		\$24	
Scotchgard Stain Protection		\$38	
MOTORIZATION*		MORE INFO	ADD
PowerTouch Rechargeable		Pg 60	\$132
Simplicity Rechargeable Motorization - Motor with Integrated Battery		Pg 54	\$368
Plug-In Charger for Li-Ion Battery Pack (used for PowerTouch and Simplicity Rechargeable and is required)		Pg 56	\$30
Simplicity 5 Channel Remote		Pg 56	\$44
Simplicity 6 Channel Remote with Timer		Pg 56	\$72
Simplicity 14 Channel White Remote		Pg 58	\$72
Simplicity Smart Controller (NEO)		Pg 59	\$363
Top Down-Bottom Up Motorization and Solar Charge Option Pricing		Pg 10	
ADDITIONAL OPTIONS			
Insulating SlumberShades		\$142 (Not Available with Boutique fabric)	
Two-On-One Head Rail		\$52 Add to Cord Lock Shade and add lift system upgrade for cord loop or cordless	
Cut Outs		\$55 Per side	
Day-Night		Price each panel as separate shade and add together	
Highlights Cornice Valance		See Page 107 For More Information	

*Motorized Pricing Examples pages 10, 51, 55 and 58

Cellular Shade Collection
PRICING

Boutique 3/4" Room Darkening
Linen Weave 3/4" Room Darkening
Verona 3/4" Room Darkening

PRICE GROUP 2
Cord Lock
Cordless Lift & Lock

		Width In Inches														
		24	30	36	42	48	54	60	66	72	84	96	108	120	132	144
Length In Inches	36	259	289	332	369	408	445	482	515	554	637	716	796	880	959	1040
	42	277	317	355	402	445	485	530	569	612	703	792	883	980	1078	1177
	48	293	339	389	434	482	528	573	624	671	784	896	1008	1121	1232	1344
	54	315	360	413	464	517	568	631	693	757	883	1008	1134	1260	1386	1512
	60	334	386	445	498	553	631	701	770	840	980	1119	1260	1400	1541	1680
	66	350	408	472	540	616	693	770	848	924	1078	1232	1386	1541	1694	1847
	72	369	428	498	589	672	757	840	924	1008	1177	1344	1512	1680	1847	2015
	78	389	456	546	637	728	819	910	1001	1092	1274	1456	1638	1820	2001	2183
	84	400	490	589	686	784	883	980	1078	1177	1372	1568	1764	1959	2154	2350
	90	419	525	631	736	840	945	1050	1154	1260	1470	1680	1889	2098	2309	2518
96	449	560	672	784	896	1008	1119	1232	1344	1568	1791	2014	2239	2462	2686	
108	504	631	757	883	1008	1134	1260	1386	1512	1764	2014	2266	2518	2770	3023	
120	560	701	840	980	1119	1260	1400	1539	1680	1958	2237	2518	2798	3078	3358	

■ Cord Loop Hardware is recommended on sizes within the shaded area.
Motorized Lift Systems are not offered within the shaded area.

Widths over 108" will be built as Two-On-One Shades.

LIFT SYSTEM AND DESIGN UPGRADES		ADD	
Cord Lock	Top Down-Bottom Up	\$68	
Cordless Lift & Lock	Bottom Up	No Charge	
	Top Down-Bottom Up	\$88	
Cordless Ultra	Bottom Up	\$88	
	Top Down-Bottom Up	\$175	
Cord Loop	Bottom Up	\$88	
	Top Down-Bottom Up	\$175	
DESIGNER UPGRADE OPTIONS (Add to any Lift System Upgrade Above)		ADD	
Metallic Hardware or Fabric Wrapped Hardware		\$24	
Scotchgard Stain Protection		\$38	
MOTORIZATION*		MORE INFO	ADD
PowerTouch Rechargeable		Pg 60	\$132
Simplicity Rechargeable Motorization - Motor with Integrated Battery		Pg 54	\$368
Plug-In Charger for Li-Ion Battery Pack (used for PowerTouch and Simplicity Rechargeable and is required)		Pg 56	\$30
Simplicity 5 Channel Remote		Pg 56	\$44
Simplicity 6 Channel Remote with Timer		Pg 56	\$72
Simplicity 14 Channel White Remote		Pg 58	\$72
Simplicity Smart Controller (NEO)		Pg 59	\$363
Top Down-Bottom Up Motorization and Solar Charge Option Pricing		Pg 10	
ADDITIONAL OPTIONS			
Insulating SlumberShades		\$142 (Not Available with Boutique fabric)	
Two-On-One Head Rail		\$52 Add to Cord Lock Shade and add lift system upgrade for cord loop or cordless	
Cut Outs		\$55 Per side	
Day-Night		Price each panel as separate shade and add together	
Highlights Cornice Valance		See Page 107 For More Information	

*Pricing Examples pages 10, 51, 55 and 58

Cellular Shade Collection
PRICING

Premiere 1/2" Light Filtering

PRICE GROUP 3
Cord Lock
Cordless Lift & Lock

		Width In Inches														
		24	30	36	42	48	54	60	66	72	84	96	108	120	132	144
Length In Inches	36	148	165	190	211	233	254	275	294	316	364	409	454	502	548	593
	42	158	181	203	230	254	277	303	325	350	402	452	504	559	615	671
	48	167	194	222	248	275	301	327	356	383	447	511	575	639	703	767
	54	180	206	236	265	296	324	360	396	432	504	575	647	719	791	863
	60	191	221	254	284	316	360	400	439	479	559	639	719	799	879	958
	66	200	233	270	308	352	396	439	484	528	615	703	791	879	966	1054
	72	211	244	284	336	384	432	479	528	575	671	767	863	958	1054	1150
	78	222	261	312	364	416	467	519	571	623	727	831	934	1038	1142	1246
	84	229	280	336	392	447	504	559	615	671	782	894	1006	1118	1229	1341
	90	239	300	360	420	479	539	599	659	719	839	958	1078	1198	1318	1437
	96	256	320	384	447	511	575	639	703	767	894	1022	1149	1278	1405	1533
	108	288	360	432	504	575	647	719	791	863	1006	1149	1293	1437	1581	1725
120	320	400	479	559	639	719	799	878	958	1118	1277	1437	1596	1756	1916	

 Cord Loop Hardware is recommended on sizes within the shaded area.
Motorized Lift Systems are not offered within the shaded area.

Widths over 108" will be built as Two-On-One Shades.

STANDARD RECTANGULAR

LIFT SYSTEM AND DESIGN UPGRADES		ADD	
Cord Lock	Top Down-Bottom Up	\$68	
Cordless Lift & Lock	Bottom Up	No Charge	
	Top Down-Bottom Up	\$88	
Cordless Ultra	Bottom Up	\$88	
	Top Down-Bottom Up	\$175	
Cord Loop	Bottom Up	\$88	
	Top Down-Bottom Up	\$175	
DESIGNER UPGRADE OPTIONS (Add to any Lift System Upgrade Above)		ADD	
Metallic Hardware or Fabric Wrapped Hardware		\$24	
Scotchgard Stain Protection		\$38	
MOTORIZATION*		MORE INFO	ADD
PowerTouch Rechargeable		Pg 60	\$132
Simplicity Rechargeable Motorization - Motor with Integrated Battery		Pg 54	\$368
Plug-In Charger for Li-Ion Battery Pack (used for PowerTouch and Simplicity Rechargeable and is required)		Pg 56	\$30
Simplicity 5 Channel Remote		Pg 56	\$44
Simplicity 6 Channel Remote with Timer		Pg 56	\$72
Simplicity 14 Channel White Remote		Pg 58	\$72
Simplicity Smart Controller (NEO)		Pg 59	\$363
Top Down-Bottom Up Motorization and Solar Charge Option Pricing		Pg 10	
ADDITIONAL OPTIONS			
Insulating SlumberShades		\$142 See Page 64 For More Information	
Two-On-One Head Rail		\$52 Add to Cord Lock Shade and add lift system upgrade for cord loop or cordless	
Cut Outs		\$55 Per side	
Day-Night		Price each panel as separate shade and add together	
Highlights Cornice Valance		See Page 107 For More Information	
Prints & Custom Graphics		Add 20% - Includes Anna Cote, Gradients, Spheres, Tuscan Scroll and Custom Graphics	

*Pricing Examples pages 10, 51, 55 and 58

Cellular Shade Collection
PRICING

Premiere 1/2" Blackout

PRICE GROUP 4
Cord Lock
Cordless Lift & Lock

		Width In Inches														
		24	30	36	42	48	54	60	66	72	84	96	108	120	132	144
Length In Inches	36	193	215	247	275	303	331	358	383	411	474	532	591	653	713	771
	42	206	236	264	299	331	361	394	423	455	523	588	656	727	800	873
	48	218	253	289	323	358	392	426	463	498	582	665	748	831	914	998
	54	234	268	307	345	385	422	468	515	562	656	748	842	935	1029	1122
	60	249	288	331	370	411	468	520	571	623	727	831	935	1039	1143	1246
	66	260	303	351	401	458	515	571	630	687	800	914	1029	1143	1256	1371
	72	275	318	370	437	500	562	623	687	748	873	998	1122	1246	1371	1495
	78	289	340	406	474	541	608	675	743	810	946	1081	1215	1350	1485	1620
	84	298	364	437	510	582	656	727	800	873	1017	1163	1308	1454	1598	1744
	90	311	390	468	546	623	701	779	857	935	1091	1246	1402	1558	1714	1869
	96	333	416	500	582	665	748	831	914	998	1163	1329	1494	1662	1827	1993
	108	375	468	562	656	748	842	935	1029	1122	1308	1494	1681	1869	2056	2243
120	416	520	623	727	831	935	1039	1142	1246	1454	1661	1869	2075	2283	2491	

 Cord Loop Hardware is recommended on sizes within the shaded area.
Motorized Lift Systems are not offered within the shaded area.

Widths over 108" will be built as Two-On-One Shades.

LIFT SYSTEM AND DESIGN UPGRADES		ADD	
Cord Lock	Top Down-Bottom Up	\$68	
Cordless Lift & Lock	Bottom Up	No Charge	
	Top Down-Bottom Up	\$88	
Cordless Ultra	Bottom Up	\$88	
	Top Down-Bottom Up	\$175	
Cord Loop	Bottom Up	\$88	
	Top Down-Bottom Up	\$175	
DESIGNER UPGRADE OPTIONS (Add to any Lift System Upgrade Above)		ADD	
Metallic Hardware or Fabric Wrapped Hardware		\$24	
Scotchgard Stain Protection		\$38	
MOTORIZATION*		MORE INFO	ADD
PowerTouch Rechargeable		Pg 60	\$132
Simplicity Rechargeable Motorization - Motor with Integrated Battery		Pg 54	\$368
Plug-In Charger for Li-Ion Battery Pack (used for PowerTouch and Simplicity Rechargeable and is required)		Pg 56	\$30
Simplicity 5 Channel Remote		Pg 56	\$44
Simplicity 6 Channel Remote with Timer		Pg 56	\$72
Simplicity 14 Channel White Remote		Pg 58	\$72
Simplicity Smart Controller (NEO)		Pg 59	\$363
Top Down-Bottom Up Motorization and Solar Charge Option Pricing		Pg 10	
ADDITIONAL OPTIONS			
Insulating SlumberShades		\$142 See Page 64 For More Information	
Two-On-One Head Rail		\$52 Add to Cord Lock Shade and add lift system upgrade for cord loop or cordless	
Cut Outs		\$55 Per side	
Day-Night		Price each panel as separate shade and add together	
Highlights Cornice Valance		See Page 107 For More Information	
Prints & Custom Graphics		Add 20% - Includes Anna Cote, Gradients, Spheres, Tuscan Scroll, Homespun, Florence, Strata, Blossom, Country Woven and Custom Graphics	

*Pricing Examples pages 10, 51, 55 and 58

STANDARD RECTANGULAR

Cellular Shade Collection
PRICING

Premiere 3/4" Light Filtering

PRICE GROUP 5
Cord Lock
Cordless Lift & Lock

		Width In Inches														
		24	30	36	42	48	54	60	66	72	84	96	108	120	132	144
Length In Inches	36	163	182	209	233	257	280	303	324	348	401	450	500	553	603	653
	42	174	200	224	253	280	305	334	358	385	443	498	555	615	677	739
	48	184	214	245	273	303	332	360	392	422	492	563	633	703	774	844
	54	198	227	260	292	326	357	396	436	476	555	633	712	791	871	950
	60	211	244	280	313	348	396	440	483	527	615	703	791	879	967	1054
	66	220	257	297	339	388	436	483	533	581	677	774	871	967	1063	1160
	72	233	269	313	370	423	476	527	581	633	739	844	950	1054	1160	1265
	78	245	288	344	401	458	514	571	629	686	800	915	1028	1142	1257	1371
	84	252	308	370	432	492	555	615	677	739	861	984	1107	1230	1352	1476
	90	263	330	396	462	527	593	659	725	791	923	1054	1186	1318	1450	1581
	96	282	352	423	492	563	633	703	774	844	984	1125	1264	1406	1546	1687
	108	317	396	476	555	633	712	791	871	950	1107	1264	1423	1581	1740	1898
120	352	440	527	615	703	791	879	966	1054	1230	1405	1581	1756	1932	2108	

 Cord Loop Hardware is recommended on sizes within the shaded area.
Motorized Lift Systems are not offered within the shaded area.

Widths over 108" will be built as Two-On-One Shades.

STANDARD RECTANGULAR

LIFT SYSTEM AND DESIGN UPGRADES		ADD	
Cord Lock	Top Down-Bottom Up	\$68	
Cordless Lift & Lock	Bottom Up	No Charge	
	Top Down-Bottom Up	\$88	
Cordless Ultra	Bottom Up	\$88	
	Top Down-Bottom Up	\$175	
Cord Loop	Bottom Up	\$88	
	Top Down-Bottom Up	\$175	
DESIGNER UPGRADE OPTIONS (Add to any Lift System Upgrade Above)		ADD	
Metallic Hardware or Fabric Wrapped Hardware		\$24	
Scotchgard Stain Protection		\$38	
MOTORIZATION*		MORE INFO	ADD
PowerTouch Rechargeable		Pg 60	\$132
Simplicity Rechargeable Motorization - Motor with Integrated Battery		Pg 54	\$368
Plug-In Charger for Li-Ion Battery Pack (used for PowerTouch and Simplicity Rechargeable and is required)		Pg 56	\$30
Simplicity 5 Channel Remote		Pg 56	\$44
Simplicity 6 Channel Remote with Timer		Pg 56	\$72
Simplicity 14 Channel White Remote		Pg 58	\$72
Simplicity Smart Controller (NEO)		Pg 59	\$363
Top Down-Bottom Up Motorization and Solar Charge Option Pricing		Pg 10	
ADDITIONAL OPTIONS			
Insulating SlumberShades		\$142 See Page 64 For More Information	
Two-On-One Head Rail		\$52 Add to Cord Lock Shade and add lift system upgrade for cord loop or cordless	
Cut Outs		\$55 Per side	
Day-Night		Price each panel as separate shade and add together	
Highlights Cornice Valance		See Page 107 For More Information	
Prints & Custom Graphics		Add 20% - Includes Anna Cote, Gradients, Spheres, Tuscan Scroll and Custom Graphics	

*Pricing Examples pages 10, 51, 55 and 58

Cellular Shade Collection
PRICING

Premiere 3/4" Karma-Light Room Darkening & Blackout

PRICE GROUP 6
Cord Lock
Cordless Lift & Lock

Width In Inches

Length In Inches	Width In Inches														
	24	30	36	42	48	54	60	66	72	84	96	108	120	132	144
36	212	237	272	303	335	364	394	422	453	522	585	650	719	784	849
42	227	260	292	329	364	397	435	466	501	576	648	722	800	881	961
48	240	279	319	355	394	432	468	510	549	640	732	823	914	1007	1098
54	258	296	338	380	424	465	515	567	619	722	823	926	1029	1133	1235
60	275	318	364	407	453	515	572	628	686	800	914	1029	1143	1258	1371
66	286	335	387	441	505	567	628	693	756	881	1007	1133	1258	1382	1508
72	303	350	407	481	550	619	686	756	823	961	1098	1235	1371	1508	1645
78	319	375	448	522	596	669	743	818	892	1040	1190	1337	1485	1635	1783
84	328	401	481	562	640	722	800	881	961	1120	1280	1440	1599	1758	1919
90	342	429	515	601	686	771	857	943	1029	1200	1371	1542	1714	1885	2056
96	367	458	550	640	732	823	914	1007	1098	1280	1463	1644	1828	2010	2194
108	413	515	619	722	823	926	1029	1133	1235	1440	1644	1850	2056	2262	2468
120	458	572	686	800	914	1029	1143	1256	1371	1599	1827	2056	2283	2512	2741

 Cord Loop Hardware is recommended on sizes within the shaded area.
Motorized Lift Systems are not offered within the shaded area.

Widths over 108" will be built as Two-On-One Shades.

STANDARD RECTANGULAR

LIFT SYSTEM AND DESIGN UPGRADES		ADD	
Cord Lock	Top Down-Bottom Up	\$68	
Cordless Lift & Lock	Bottom Up	No Charge	
	Top Down-Bottom Up	\$88	
Cordless Ultra	Bottom Up	\$88	
	Top Down-Bottom Up	\$175	
Cord Loop	Bottom Up	\$88	
	Top Down-Bottom Up	\$175	
DESIGNER UPGRADE OPTIONS (Add to any Lift System Upgrade Above)		ADD	
Metallic Hardware or Fabric Wrapped Hardware		\$24	
Scotchgard Stain Protection		\$38	
MOTORIZATION*		MORE INFO	ADD
PowerTouch Rechargeable		Pg 60	\$132
Simplicity Rechargeable Motorization - Motor with Integrated Battery		Pg 54	\$368
Plug-In Charger for Li-Ion Battery Pack (used for PowerTouch and Simplicity Rechargeable and is required)		Pg 56	\$30
Simplicity 5 Channel Remote		Pg 56	\$44
Simplicity 6 Channel Remote with Timer		Pg 56	\$72
Simplicity 14 Channel White Remote		Pg 58	\$72
Simplicity Smart Controller (NEO)		Pg 59	\$363
Top Down-Bottom Up Motorization and Solar Charge Option Pricing		Pg 10	
ADDITIONAL OPTIONS			
Insulating SlumberShades		\$142 See Page 64 For More Information	
Two-On-One Head Rail		\$52 Add to Cord Lock Shade and add lift system upgrade for cord loop or cordless	
Cut Outs		\$55 Per side	
Day-Night		Price each panel as separate shade and add together	
Highlights Cornice Valance		See Page 107 For More Information	
Prints & Custom Graphics		Add 20% - Includes Anna Cote, Gradients, Spheres, Tuscan Scroll, Homespun, Florence, Strata, Blossom, Country Woven and Custom Graphics	

*Pricing Examples pages 10, 51, 55 and 58

Cellular Shade Collection
PRICING

Debut 1/2" Single Cell

PRICE GROUP 7
Cord Lock
Cordless Lift & Lock

		Width In Inches														
		24	30	36	42	48	54	60	66	72	84	96	108	120	132	144
Length In Inches	36	141	158	181	201	223	242	263	281	302	347	390	434	480	523	567
	42	151	173	194	219	242	264	289	310	334	383	431	481	534	587	641
	48	160	185	212	237	263	288	313	340	366	427	488	549	610	671	732
	54	172	196	225	253	282	310	344	378	412	481	549	617	686	755	823
	60	182	211	242	271	301	344	382	419	458	534	610	686	763	839	915
	66	191	223	257	294	336	378	419	462	504	587	671	755	839	922	1006
	72	201	233	271	321	366	412	458	504	549	641	732	823	915	1006	1098
	78	212	249	298	347	397	446	496	545	595	694	793	892	991	1090	1189
	84	218	267	321	374	427	481	534	587	641	747	854	961	1067	1174	1280
	90	228	286	344	401	458	515	572	629	686	801	915	1029	1143	1258	1372
	96	245	305	366	427	488	549	610	671	732	854	975	1097	1220	1341	1463
108	275	344	412	481	549	617	686	755	823	961	1097	1234	1372	1509	1646	
120	305	382	458	534	610	686	763	838	915	1067	1219	1372	1524	1677	1829	

Widths over 108" will be built as Two-On-One Shades.

STANDARD RECTANGULAR

LIFT SYSTEM AND DESIGN UPGRADES			ADD	
Cord Lock	Top Down-Bottom Up		\$68	
Cordless Lift & Lock	Bottom Up		No Charge	
	Top Down-Bottom Up		\$88	
Cordless Ultra	Bottom Up		\$88	
	Top Down-Bottom Up		\$175	
Cord Loop	Bottom Up		\$88	
	Top Down-Bottom Up		\$175	
DESIGNER UPGRADE OPTIONS (Add to any Lift System Upgrade Above)			ADD	
Metallic Hardware or Fabric Wrapped Hardware			\$24	
Scotchgard Stain Protection			\$38	
MOTORIZATION*			MORE INFO	ADD
PowerTouch Rechargeable			Pg 60	\$132
Simplicity Rechargeable Motorization - Motor with Integrated Battery			Pg 54	\$368
Plug-In Charger for Li-Ion Battery Pack (used for PowerTouch and Simplicity Rechargeable and is required)			Pg 56	\$30
Simplicity 5 Channel Remote			Pg 56	\$44
Simplicity 6 Channel Remote with Timer			Pg 56	\$72
Simplicity 14 Channel White Remote			Pg 58	\$72
Simplicity Smart Controller (NEO)			Pg 59	\$363
Top Down-Bottom Up Motorization and Solar Charge Option Pricing			Pg 10	
ADDITIONAL OPTIONS				
Insulating SlumberShades		\$142 See Page 64 For More Information		
Two-On-One Head Rail		\$52 Add to Cord Lock Shade and add lift system upgrade for cord loop or cordless		
Cut Outs		\$55 Per side		
Day-Night		Price each panel as separate shade and add together		
Highlights Cornice Valance		See Page 107 For More Information		
Prints & Custom Graphics		Add 20% - Includes Homespun, Country Woven, Florance, Strata, Angel Hair, Blossom, Strie and Terrazzo.		

*Pricing Examples pages 10, 51, 55 and 58

Cellular Shade Collection
PRICING

Debut 3/4" Single Cell
Debut 1/2" Double Cell

PRICE GROUP 8
Cord Lock
Cordless Lift & Lock

		Width In Inches														
		24	30	36	42	48	54	60	66	72	84	96	108	120	132	144
Length In Inches	36	156	174	200	222	246	267	290	310	333	382	429	478	528	576	624
	42	167	191	214	241	267	291	318	341	368	422	475	530	588	646	706
	48	176	204	234	261	290	317	345	374	403	470	537	604	671	739	806
	54	190	216	248	279	311	341	379	416	454	530	604	679	755	831	906
	60	201	233	267	299	332	379	421	461	504	588	671	755	840	923	1007
	66	211	246	283	324	370	416	461	509	555	646	739	831	923	1015	1107
	72	222	257	299	354	403	454	504	555	604	706	806	906	1007	1107	1208
	78	234	274	328	382	437	491	546	600	655	764	873	982	1091	1199	1308
	84	240	294	354	412	470	530	588	646	706	822	940	1058	1174	1292	1408
	90	251	315	379	442	504	567	630	692	755	882	1007	1132	1258	1384	1510
	96	270	336	403	470	537	604	671	739	806	940	1073	1207	1342	1476	1610
108	303	379	454	530	604	679	755	831	906	1058	1207	1358	1510	1660	1811	
120	336	421	504	588	671	755	840	922	1007	1174	1341	1510	1677	1845	2012	

Widths over 108" will be built as Two-On-One Shades.

STANDARD RECTANGULAR

LIFT SYSTEM AND DESIGN UPGRADES		ADD	
Cord Lock	Top Down-Bottom Up	\$68	
Cordless Lift & Lock	Bottom Up	No Charge	
	Top Down-Bottom Up	\$88	
Cordless Ultra	Bottom Up	\$88	
	Top Down-Bottom Up	\$175	
Cord Loop	Bottom Up	\$88	
	Top Down-Bottom Up	\$175	
DESIGNER UPGRADE OPTIONS (Add to any Lift System Upgrade Above)		ADD	
Metallic Hardware or Fabric Wrapped Hardware		\$24	
Scotchgard Stain Protection		\$38	
MOTORIZATION*		MORE INFO	ADD
PowerTouch Rechargeable		Pg 60	\$132
Simplicity Rechargeable Motorization - Motor with Integrated Battery		Pg 54	\$368
Plug-In Charger for Li-Ion Battery Pack (used for PowerTouch and Simplicity Rechargeable and is required)		Pg 56	\$30
Simplicity 5 Channel Remote		Pg 56	\$44
Simplicity 6 Channel Remote with Timer		Pg 56	\$72
Simplicity 14 Channel White Remote		Pg 58	\$72
Simplicity Smart Controller (NEO)		Pg 59	\$363
Top Down-Bottom Up Motorization and Solar Charge Option Pricing		Pg 10	
ADDITIONAL OPTIONS			
Insulating SlumberShades		\$142 See Page 64 For More Information	
Two-On-One Head Rail		\$52 Add to Cord Lock Shade and add lift system upgrade for cord loop or cordless	
Cut Outs		\$55 Per side	
Day-Night		Price each panel as separate shade and add together	
Highlights Cornice Valance		See Page 107 For More Information	
Prints & Custom Graphics		Add 20% - Includes Homespun, Country Woven, Florance, Strata, Angel Hair, Blossom, Strie and Terrazzo.	

*Pricing Examples pages 10, 51, 55 and 58

Cellular Shade Collection
PRICING

Symphony 3/8" Light Filtering

PRICE GROUP 9
Cord Lock
Cordless Lift & Lock

Length In Inches	Width In Inches														
	24	30	36	42	48	54	60	66	72	84	96	108	120	132	144
36	134	150	172	191	212	230	250	267	287	330	371	412	456	497	539
42	144	164	184	208	230	251	275	295	317	365	410	458	508	559	610
48	152	176	201	225	250	274	297	323	348	406	464	522	581	639	697
54	163	187	214	241	268	294	327	359	392	458	522	588	653	718	784
60	173	200	230	258	286	327	363	399	435	508	580	653	726	799	871
66	181	212	245	280	319	359	399	439	479	559	639	718	799	878	958
72	191	222	258	305	348	392	435	479	522	610	697	784	871	958	1045
78	201	237	283	330	377	425	472	519	566	660	755	849	943	1038	1132
84	208	254	305	356	406	458	508	559	610	711	813	914	1016	1117	1219
90	217	272	327	381	435	490	544	598	653	762	871	979	1088	1197	1306
96	232	290	348	406	464	522	580	639	697	813	929	1044	1161	1277	1393
108	261	327	392	458	522	588	653	718	784	914	1044	1175	1306	1437	1567
120	290	363	435	508	580	653	726	798	871	1015	1160	1306	1451	1596	1741

 Cord Loop Hardware is recommended on sizes within the shaded area.
Motorized Lift Systems are not offered within the shaded area.

Widths over 108" will be built as Two-On-One Shades.

STANDARD RECTANGULAR

FABRIC SURCHARGES		ADD	
Prints and Duotones		20%	
Flame Resistant 3/8" double cell		30%	
Flame Resistant 3/4" single cell		30%	
LIFT SYSTEM AND DESIGN UPGRADES		ADD	
Cord Lock	Top Down-Bottom Up	\$68	
Cordless Lift & Lock	Bottom Up	No Charge	
	Top Down-Bottom Up	\$88	
Cordless Ultra	Bottom Up	\$88	
	Top Down-Bottom Up	\$175	
Cord Loop	Bottom Up	\$88	
	Top Down-Bottom Up	\$175	
DESIGNER UPGRADE OPTIONS (Add to any Lift System Upgrade Above)		ADD	
Metallic Hardware or Fabric Wrapped Hardware		\$24	
Scotchgard Stain Protection		\$38	
MOTORIZATION*		MORE INFO	ADD
PowerTouch Rechargeable		Pg 60	\$132
Simplicity Rechargeable Motorization - Motor with Integrated Battery		Pg 54	\$368
Plug-In Charger for Li-Ion Battery Pack (used for PowerTouch and Simplicity Rechargeable and is required)		Pg 56	\$30
Simplicity 5 Channel Remote		Pg 56	\$44
Simplicity 6 Channel Remote with Timer		Pg 56	\$72
Simplicity 14 Channel White Remote		Pg 58	\$72
Simplicity Smart Controller (NEO)		Pg 59	\$363
Top Down-Bottom Up Motorization and Solar Charge Option Pricing		Pg 10	
ADDITIONAL OPTIONS			
Insulating SlumberShades		\$142 See Page 64 For More Information	
Two-On-One Head Rail		\$52 Add to Cord Lock Shade and add lift system upgrade for cord loop or cordless	
Cut Outs		\$55 Per side	
Day-Night		Price each panel as separate shade and add together	
Highlights Cornice Valance		See Page 107 For More Information	

*Pricing Examples pages 10, 51, 55 and 58

Cellular Shade Collection
PRICING

Symphony 3/8" Blackout

PRICE GROUP 10
Cord Lock
Cordless Lift & Lock

		Width In Inches														
		24	30	36	42	48	54	60	66	72	84	96	108	120	132	144
Length In Inches	36	175	195	224	249	276	300	325	347	374	430	483	537	594	647	701
	42	187	214	240	271	300	327	358	384	413	474	534	595	661	727	793
	48	198	229	262	293	325	356	387	421	453	529	604	679	756	831	906
	54	212	243	279	313	349	383	425	467	510	595	679	764	849	934	1019
	60	226	261	300	336	373	425	473	519	566	661	755	849	944	1039	1132
	66	236	276	318	364	416	467	519	572	623	727	831	934	1039	1142	1245
	72	249	289	336	397	453	510	566	623	679	793	906	1019	1132	1245	1359
	78	262	308	368	430	491	552	614	675	736	859	982	1104	1227	1350	1472
	84	270	331	397	463	529	595	661	727	793	925	1057	1189	1322	1453	1585
	90	283	354	425	496	566	637	708	778	849	991	1132	1273	1415	1557	1698
	96	303	378	453	529	604	679	755	831	906	1057	1208	1358	1510	1661	1811
	108	340	425	510	595	679	764	849	934	1019	1189	1358	1528	1698	1868	2038
120	378	473	566	661	755	849	944	1038	1132	1321	1509	1698	1887	2076	2264	

■ Cord Loop Hardware is recommended on sizes within the shaded area.
Motorized Lift Systems are not offered within the shaded area.

Widths over 120" will be built as Two-On-One Shades.

STANDARD RECTANGULAR

LIFT SYSTEM AND DESIGN UPGRADES		ADD	
Cord Lock	Top Down-Bottom Up	\$68	
Cordless Lift & Lock	Bottom Up	No Charge	
	Top Down-Bottom Up	\$88	
Cord Loop	Bottom Up	\$88	
	Top Down-Bottom Up	\$175	
DESIGNER UPGRADE OPTIONS (Add to any Lift System Upgrade Above)		ADD	
Metallic Hardware or Fabric Wrapped Hardware		\$24	
Scotchgard Stain Protection		\$38	
MOTORIZATION*		MORE INFO	ADD
PowerTouch Rechargeable		Pg 60	\$132
Simplicity Rechargeable Motorization - Motor with Integrated Battery		Pg 54	\$368
Plug-In Charger for Li-Ion Battery Pack (used for PowerTouch and Simplicity Rechargeable and is required)		Pg 56	\$30
Simplicity 5 Channel Remote		Pg 56	\$44
Simplicity 6 Channel Remote with Timer		Pg 56	\$72
Simplicity 14 Channel White Remote		Pg 58	\$72
Simplicity Smart Controller (NEO)		Pg 59	\$363
Top Down-Bottom Up Motorization and Solar Charge Option Pricing		Pg 10	
ADDITIONAL OPTIONS			
Insulating SlumberShades		\$142 See Page 64 For More Information	
Two-On-One Head Rail		\$52 Add to Cord Lock Shade and add lift system upgrade for cord loop or cordless	
Cut Outs		\$55 Per side	
Day-Night		Price each panel as separate shade and add together	
Highlights Cornice Valance		See Page 107 For More Information	

*Pricing Examples pages 10, 51, 55 and 58

Cellular Shade Collection
PRICING

Prelude 3/4" Light Filtering

PRICE GROUP 11
Cord Lock
Cordless Lift & Lock

		Width In Inches												
		24	30	36	42	48	54	60	66	72	84	96	108	120
Length In Inches	36	121	135	155	173	191	208	225	241	259	298	335	372	411
	42	130	148	166	188	208	227	248	266	286	329	370	412	458
	48	137	159	182	203	225	247	268	292	313	366	418	471	523
	54	147	168	193	217	242	266	295	324	353	412	471	529	588
	60	156	181	208	233	258	295	327	360	392	458	523	588	654
	66	164	191	221	252	288	324	360	396	432	503	575	647	719
	72	173	200	233	275	314	353	392	432	471	549	628	706	784
	78	182	213	255	298	340	383	425	467	510	595	680	765	850
	84	187	229	275	321	366	412	458	503	549	640	732	823	915
	90	196	246	295	344	392	441	491	539	588	686	784	882	980
	96	210	262	314	366	418	471	523	575	628	732	836	941	1045
	108	236	295	353	412	471	529	588	647	706	823	941	1058	1176
120	262	327	392	458	523	588	654	719	784	914	1045	1176	1306	

■ Cord Loop Hardware is recommended on sizes within the shaded area.

Motorized lift systems are not offered within the shaded area.

STANDARD RECTANGULAR

LIFT SYSTEM AND DESIGN UPGRADES		ADD	
Cord Lock	Top Down-Bottom Up	\$68	
Cordless Lift & Lock	Bottom Up	No Charge	
	Top Down-Bottom Up	\$88	
Cordless Ultra	Bottom Up	\$88	
	Top Down-Bottom Up	\$175	
Cord Loop	Bottom Up	\$88	
	Top Down-Bottom Up	\$175	
DESIGNER UPGRADE OPTIONS (Add to any Lift System Upgrade Above - Not available on Cord Lock)		ADD	
Metallic Hardware (Not available on Lift & Lock or Cord Lock) or Fabric Wrapped Hardware (Not available on Cord Lock)		\$24	
MOTORIZATION*		MORE INFO	ADD
PowerTouch Rechargeable		Pg 60	\$132
Simplicity Rechargeable Motorization - Motor with Integrated Battery		Pg 54	\$368
Plug-In Charger for Li-Ion Battery Pack (used for PowerTouch and Simplicity Rechargeable and is required)		Pg 56	\$30
Simplicity 5 Channel Remote		Pg 56	\$44
Simplicity 6 Channel Remote with Timer		Pg 56	\$72
Simplicity 14 Channel White Remote		Pg 58	\$72
Simplicity Smart Controller (NEO)		Pg 59	\$363
Top Down-Bottom Up Motorization not available on Prelude		Pg 10	
ADDITIONAL OPTIONS AND ACCESSORIES			
Insulating SlumberShades		Not Available	
Two-On-One/Three-On-One Head Rail		\$52 (Two-On-One) \$105(Three-On-One) Add to Cord Lock Shade and add lift system upgrade for cord loop or cordless	
Highlights Cornice Valance		See Page 107 For More Information	
6 foot expandable pole		\$44	

*Pricing Examples pages 10, 51, 55 and 58

Cellular Shade Collection
PRICING

Prelude 3/4" Blackout

PRICE GROUP 12
Cord Lock
Cordless Lift & Lock

STANDARD RECTANGULAR

		Width In Inches												
		24	30	36	42	48	54	60	66	72	84	96	108	120
Length In Inches	36	164	183	210	234	258	281	304	326	350	403	453	503	555
	42	176	200	225	254	281	307	335	360	387	445	500	557	619
	48	185	215	246	275	304	334	362	395	423	495	565	636	707
	54	199	227	261	293	327	360	399	438	477	557	636	715	794
	60	211	245	281	315	349	399	442	486	530	619	707	794	883
	66	222	258	299	341	389	438	486	535	584	680	777	874	971
	72	234	270	315	372	424	477	530	584	636	742	848	954	1059
	78	246	288	345	403	459	518	574	631	689	804	918	1033	1148
	84	253	310	372	434	495	557	619	680	742	864	989	1112	1236
	90	265	333	399	465	530	596	663	728	794	927	1059	1191	1323
	96	284	354	424	495	565	636	707	777	848	989	1129	1271	1411
	108	319	399	477	557	636	715	794	874	954	1112	1271	1429	1588
120	354	442	530	619	707	794	883	971	1059	1234	1411	1588	1764	

■ Cord Loop Hardware is recommended on sizes within the shaded area.

Motorized lift systems are not offered within the shaded area.

LIFT SYSTEM AND DESIGN UPGRADES		ADD	
Cord Lock	Top Down-Bottom Up	\$68	
Cordless Lift & Lock	Bottom Up	No Charge	
	Top Down-Bottom Up	\$88	
Cordless Ultra	Bottom Up	\$88	
	Top Down-Bottom Up	\$175	
Cord Loop	Bottom Up	\$88	
	Top Down-Bottom Up	\$175	
DESIGNER UPGRADE OPTIONS (Add to any Lift System Upgrade Above - Not available on Cord Lock)		ADD	
Metallic Hardware (Not available on Lift & Lock or Cord Lock) or Fabric Wrapped Hardware (Not available on Cord Lock)		\$24	
MOTORIZATION*		MORE INFO	ADD
PowerTouch Rechargeable		Pg 60	\$132
Simplicity Rechargeable Motorization - Motor with Integrated Battery		Pg 54	\$368
Plug-In Charger for Li-Ion Battery Pack (used for PowerTouch and Simplicity Rechargeable and is required)		Pg 56	\$30
Simplicity 5 Channel Remote		Pg 56	\$44
Simplicity 6 Channel Remote with Timer		Pg 56	\$72
Simplicity 14 Channel White Remote		Pg 58	\$72
Simplicity Smart Controller (NEO)		Pg 59	\$363
Top Down-Bottom Up Motorization not available on Prelude		Pg 9	
ADDITIONAL OPTIONS AND ACCESSORIES			
Insulating SlumberShades		Not Available	
Two-On-One/Three-On-One Head Rail		\$52 Add to Cord Lock Shade and add lift system upgrade for cord loop or cordless	
Highlights Cornice Valance		See Page 107 For More Information	
6 foot expandable pole		\$44	

*Pricing Examples pages 10, 51, 55 and 58

Ovation Cellular Slider Shade
SIZE STANDARDS



Ovation Cellular Slider		
Standard		
ALL FABRICS	Minimum Width	12"
	Minimum Length	24"

Light Filtering	Price Group	Page	Ovation Cellular Slider	
Debut 1/2" Single Debut 1/2" Double Premiere 1/2" Symphony 3/8"	13	24	Maximum Width & Length	120"* x 108"
Verona 3/4" Boutique 3/4" Debut 3/4" Linen Weave 3/4" Premiere 3/4"	13	24	Maximum Width & Length	168"* x 108"
Prelude 3/4"	14	24	Maximum Width & Length	168"* x 120"

Room Darkening & Blackout	Price Group	Page	Ovation Cellular Slider	
Verona 3/4" Boutique 3/4" Linen Weave 3/4" Premiere 3/4"	15	25	Maximum Width & Length	168"* x 108"
Prelude 3/4"	16	25	Maximum Width & Length	168"* x 120"

Maximum Square Footage Side=100"
 Split=140"

Ovation Cellular Slider	
More Information On Page	Page 98

- * Split stack sliders are available in widths up to 240"; however, if the width exceeds 120", it will be fabricated as two separate sliders. The supplied valance will create the appearance of a single slider.
- ** Split stack sliders are available to 336", however if the width exceeds 168", the shade will be fabricated as two separate sliders. Supplied valance will create the appearance of a single slider. Please call customer service for assistance.
- *** Prelude split stack can go up to 190" wide on one head rail.

Ovation Cellular Slider Shade
PRICING

LIGHT FILTERING FABRICS

Boutique 3/4"
Debut 1/2" Single Cell
Debut 1/2" Double Cell
Debut 3/4" Single Cell

Linen Weave 3/4"
Premiere 1/2"
Premiere 3/4"
Symphony 3/8"

Verona 3/4"
Virtuoso 1/2"

PRICE GROUP 13
Ovation Cellular Slider

Width In Inches

	24	30	36	42	48	54	60	66	72	78	84	96	108	120	132	144	156	168
36	488	527	575	618	654	698	743	781	825	871	908	984	1059	1138	1216	1295	1377	1456
42	519	568	620	669	710	758	809	854	905	952	995	1082	1164	1259	1351	1445	1536	1630
48	553	602	665	718	766	818	874	929	983	1029	1083	1184	1275	1378	1480	1582	1682	1786
54	583	645	707	767	819	877	934	999	1059	1113	1172	1281	1384	1496	1610	1722	1836	1947
60	616	681	748	814	874	937	1003	1071	1133	1195	1257	1379	1493	1615	1741	1863	1988	2114
66	651	722	795	865	929	998	1064	1144	1209	1281	1339	1480	1602	1735	1864	1997	2128	2260
72	687	761	838	916	989	1060	1132	1215	1287	1363	1428	1583	1710	1858	2006	2154	2304	2450
78	722	802	884	968	1045	1122	1198	1290	1366	1446	1516	1677	1818	1975	2130	2286	2447	2602
84	758	842	928	1022	1105	1184	1267	1361	1446	1529	1604	1777	1928	2092	2260	2426	2592	2757
90	791	880	977	1074	1158	1246	1337	1437	1524	1613	1697	1878	2033	2217	2401	2584	2768	2952
96	823	920	1023	1124	1214	1305	1408	1510	1604	1699	1785	1978	2145	2334	2523	2711	2902	3090
108	855	956	1067	1177	1268	1366	1474	1580	1681	1785	1872	2081	2255	2451	2644	2838	3032	3226
114	900	1004	1122	1235	1334	1435	1557	1664	1771	1881	1973	2194	2380	2580	2769	2963	3155	3349
120	944	1053	1181	1295	1397	1504	1636	1746	1861	1977	2074	2306	2502	2706	2908	3107	3307	3507

Prelude 3/4" Light Filtering

PRICE GROUP 14
Ovation Cellular Slider

Width In Inches

	24	30	36	42	48	54	60	66	72	78	84	96	108	120	132	144	156	168
36	362	392	427	459	486	519	552	581	613	648	675	731	787	846	904	963	1024	1082
42	386	423	460	497	528	564	602	635	673	708	739	804	865	936	1005	1074	1143	1212
48	411	448	495	533	569	608	649	691	730	765	805	881	948	1025	1100	1177	1251	1328
54	433	479	525	570	609	652	694	743	787	828	872	953	1029	1113	1197	1280	1366	1449
60	459	506	557	605	649	696	746	796	843	889	935	1026	1110	1201	1295	1386	1478	1572
66	484	537	591	643	691	742	792	851	900	953	996	1100	1191	1290	1386	1485	1583	1681
72	511	566	622	681	736	788	842	903	957	1014	1062	1178	1271	1382	1492	1602	1713	1822
78	537	596	657	720	777	835	891	959	1016	1075	1127	1247	1351	1468	1584	1701	1819	1935
84	564	626	690	760	821	881	942	1012	1075	1137	1193	1322	1433	1556	1681	1804	1927	2051
90	588	655	727	799	861	927	994	1069	1134	1199	1261	1396	1512	1648	1785	1922	2059	2196
96	612	684	761	836	902	971	1047	1123	1193	1263	1327	1471	1595	1736	1876	2016	2159	2298
102	636	711	793	875	943	1016	1097	1175	1251	1327	1392	1548	1677	1823	1966	2111	2255	2399
108	669	747	835	918	991	1067	1158	1237	1317	1399	1467	1631	1770	1918	2060	2204	2347	2491
114	702	783	878	963	1039	1118	1216	1298	1384	1470	1542	1715	1861	2013	2162	2311	2459	2609
120	735	820	918	1009	1089	1170	1278	1359	1450	1543	1615	1799	1953	2108	2263	2418	2571	2728

PRODUCT INFORMATION	
See Page 98 for detailed information.	
DESIGN UPGRADES	
Left or Right Stack	Included, specify when ordering
Center Stack	Add \$88
Split Stack*	Price by dividing the full width measurement in half. Price as two separate units and add together.
Dual Panel**	Price as two separate units and add together.
FABRIC SURCHARGES	
Prints and Duotones	Add 20%
Flame Resistant 3/8" Double Cell	Add 30%
Flame Resistant 3/4" Single Cell	Add 30%

* Split stack sliders are available in widths up to 240". If the width exceeds 120", it will be fabricated as two separate sliders. The supplied valance will create the appearance of a single slider.

** A Dual Panel Stack Slider has a center opening design with a different fabric on each side, each of which can span the full width of the window. Both panels will be of equal width unless otherwise specified.

Ovation Cellular Slider Shade
PRICING

ROOM DARKENING & BLACKOUT FABRICS

Boutique 3/4"
Linen Weave 3/4"

Premiere 3/4"
Verona 3/4"

PRICE GROUP 15
Ovation Cellular Slider

		Width In Inches																	
		24	30	36	42	48	54	60	66	72	78	84	96	108	120	132	144	156	168
Length In Inches	36	635	686	748	804	851	908	966	1016	1073	1133	1181	1280	1377	1480	1581	1684	1791	1893
	42	675	739	806	870	923	986	1052	1111	1177	1238	1294	1407	1514	1637	1757	1879	1997	2119
	48	719	783	865	934	996	1064	1137	1208	1278	1338	1408	1540	1658	1792	1924	2057	2187	2322
	54	758	839	920	998	1065	1141	1215	1299	1377	1447	1524	1666	1800	1945	2093	2239	2387	2532
	60	801	886	973	1059	1137	1219	1304	1393	1473	1554	1635	1793	1941	2100	2264	2422	2585	2749
	66	847	939	1034	1125	1208	1298	1384	1488	1572	1666	1741	1924	2083	2256	2424	2597	2767	2938
	72	894	990	1090	1191	1286	1378	1472	1580	1674	1772	1857	2058	2223	2416	2608	2801	2996	3185
	78	939	1043	1150	1259	1359	1459	1558	1677	1776	1880	1971	2181	2364	2568	2769	2972	3182	3383
	84	986	1095	1207	1329	1437	1540	1648	1770	1880	1988	2086	2311	2507	2720	2938	3154	3370	3585
	90	1029	1144	1271	1397	1506	1620	1739	1869	1982	2097	2207	2442	2643	2883	3122	3360	3599	3838
	96	1070	1196	1330	1462	1579	1697	1831	1963	2086	2209	2321	2572	2789	3035	3280	3525	3773	4017
	108	1112	1243	1388	1531	1649	1776	1917	2054	2186	2321	2434	2706	2932	3187	3438	3690	3942	4194
114	1170	1306	1459	1606	1735	1866	2025	2164	2303	2446	2565	2853	3094	3354	3600	3852	4102	4354	
120	1228	1369	1536	1684	1817	1956	2127	2270	2420	2571	2697	2998	3253	3518	3781	4040	4300	4560	

Prelude 3/4" Blackout

PRICE GROUP 16
Ovation Cellular Slider

		Width In Inches																	
		24	30	36	42	48	54	60	66	72	78	84	96	108	120	132	144	156	168
Length In Inches	36	489	530	577	620	657	701	746	785	828	875	912	987	1063	1143	1221	1301	1383	1461
	42	522	572	621	671	713	762	813	858	909	956	998	1086	1168	1264	1357	1450	1544	1637
	48	555	605	669	720	769	821	877	933	986	1033	1087	1190	1280	1384	1485	1589	1689	1793
	54	585	647	709	770	823	881	937	1004	1063	1118	1178	1287	1390	1503	1616	1728	1845	1957
	60	620	684	752	817	877	940	1008	1075	1139	1201	1263	1386	1499	1622	1749	1872	1996	2123
	66	654	725	798	869	933	1002	1070	1149	1215	1287	1345	1485	1608	1742	1872	2005	2138	2270
	72	690	765	840	920	994	1064	1137	1220	1292	1369	1434	1591	1716	1866	2015	2163	2313	2460
	78	725	805	887	972	1049	1128	1203	1295	1372	1452	1522	1684	1824	1982	2139	2297	2456	2613
	84	762	846	932	1026	1109	1190	1272	1367	1452	1535	1611	1785	1935	2101	2270	2436	2602	2769
	90	794	885	982	1079	1163	1252	1342	1444	1531	1619	1703	1885	2042	2225	2410	2595	2780	2965
	96	827	924	1028	1129	1218	1311	1414	1517	1611	1706	1792	1986	2154	2344	2533	2722	2915	3103
	102	859	960	1071	1182	1274	1372	1481	1587	1689	1792	1880	2090	2264	2462	2655	2850	3045	3239
108	904	1009	1128	1240	1338	1441	1564	1670	1778	1889	1981	2202	2390	2590	2781	2976	3169	3363	
114	948	1058	1186	1301	1403	1510	1642	1753	1869	1985	2082	2316	2513	2718	2919	3120	3320	3523	
120	993	1107	1240	1363	1471	1580	1726	1835	1958	2084	2181	2429	2637	2846	3056	3265	3471	3683	

PRODUCT INFORMATION	
See Page 98 for detailed information.	
DESIGN UPGRADES	
Left or Right Stack	Included, specify when ordering
Center Stack	Add \$88
Split Stack*	Price by dividing the full width measurement in half. Price as two separate units and add together.
Dual Panel**	Price as two separate units and add together.
FABRIC SURCHARGES	
Prints and Duotones	Add 20%
Flame Resistant 3/8" Double Cell	Add 30%
Flame Resistant 3/4" Single Cell	Add 30%

* Split stack sliders are available in widths up to 240". If the width exceeds 120", it will be fabricated as two separate sliders. The supplied valance will create the appearance of a single slider.

** A Dual Panel Stack Slider has a center opening design with a different fabric on each side, each of which can span the full width of the window. Both panels will be of equal width unless otherwise specified.

Speciality Shaped Shades
SIZE STANDARDS

SPECIALTY SHAPED SHADES

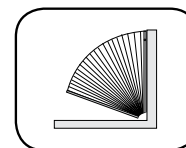
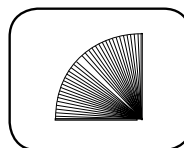
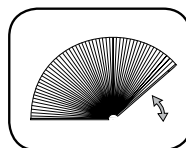
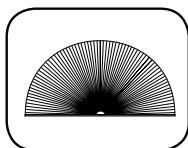

		Starburst Non-Movable Arch	Starburst Movable Arch	Quarter Round Non-Movable	Quarter Round Movable
ALL FABRICS (except 3/4" Prelude)	Minimum Width	18"	18"	9"	9"
	Minimum Length	9"	9"	9"	9"
Prelude 3/4"	Minimum Width	12"	12"	12"	12"
	Minimum Length	12"	12"	12"	12"

Light Filtering	Price Group	Page		Starburst Non-Movable Arch	Starburst Movable Arch	Quarter Round Non-Movable	Quarter Round Movable
Verona 3/4"	17	28	Maximum Width & Length	72" x 36"	72" x 36"	48" x 48"	48" x 48"
Boutique 3/4"				72" x 36"	72" x 36"	48" x 48"	48" x 46"
Debut 1/2" Double				60" x 48"	72" x 36"	48" x 48"	48" x 48"
Debut 1/2" Single				60" x 48"	72" x 36"	52" x 52"	48" x 48"
Debut 3/4"				60" x 48"	72" x 36"	48" x 48"	48" x 48"
Linen Weave 3/4"				72" x 36"	72" x 36"	48" x 48"	48" x 48"
Premiere 1/2"				60" x 48"	72" x 36"	48" x 48"	48" x 48"
Premiere 3/4"				72" x 36"	72" x 36"	48" x 48"	48" x 48"
Symphony 3/8"	18	28	Max Width & Length	96" x 48"	72" x 36"	52" x 52"	48" x 48"
Prelude 3/4"				84" x 42"	84" x 42"	42" x 42"	42" x 42"

Room Darkening & Blackout	Price Group	Page #		Starburst Non-Movable Arch	Starburst Movable Arch	Quarter Round Non-Movable	Quarter Round Movable
Verona 3/4"	19	29	Maximum Width & Length	72" x 36"	72" x 36"	48" x 48"	48" x 48"
Boutique 3/4"				72" x 36"	72" x 36"	48" x 48"	48" x 48"
Linen Weave 3/4"				72" x 36"	72" x 36"	48" x 48"	48" x 48"
Premiere 1/2"				60" x 48"	72" x 36"	48" x 48"	48" x 48"
Premiere 3/4"				72" x 36"	72" x 36"	48" x 48"	48" x 48"
Symphony 3/8"				96" x 48"	72" x 36"	52" x 52"	48" x 48"
Prelude 3/4"	20	29	Max Width & Length	84" x 42"	84" x 42"	42" x 42"	42" x 42"

	Starburst Non-Movable Arch	Starburst Movable Arch	Quarter Round Non-Movable	Quarter Round Movable
More Information On Page	Page 66	Page 66	Page 69	Page 69

* Starburst Movable Arches are available as inside mount only.
 ** Through our maximum width is 84" and our maximum is 72" on Sunset Arches, there are limitations on some larger sizes due to excessive weight. If the Sunset width exceeds 66", the maximum length is 60". If the Sunset width exceeds 72", the maximum length is 48".

Speciality Shaped Shades
SIZE STANDARDS

SPECIALTY SHAPED SHADES

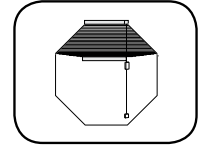
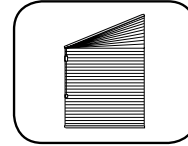
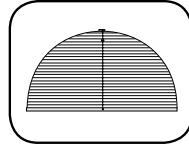

		Sunset Arch	Trapezoid	Octagon
ALL FABRICS (except 3/4" Prelude)	Minimum Width	18"	12"	12"
	Minimum Length	6"	12"	12"
Prelude 3/4"	Minimum Width	18"	12"	8"
	Minimum Length	6"	12"	8"

Light Filtering	Price Group	Page		Sunset Arch	Price Group	Page	Trapezoid	Octagon
Verona 3/4"	21	30	Maximum Width & Length	72" x 60"	25	32	48" x 72"	48" x 48"
Boutique 3/4"				72" x 60"			48" x 72"	48" x 48"
Debut 1/2" Double				84" x 72"***			60" x 72"	48" x 48"
Debut 1/2" Single				84" x 72"***			60" x 72"	48" x 48"
Debut 3/4"				84" x 72"***			60" x 72"	48" x 48"
Linen Weave 3/4"				72" x 60"			48" x 72"	48" x 48"
Premiere 1/2"				84" x 72"***			60" x 72"	48" x 48"
Premiere 3/4"				84" x 72"***			48" x 72"	48" x 48"
Symphony 3/8"				84" x 72"***			60" x 72"	48" x 48"
Prelude 3/4"	29	35	Max Width & Length	84" x 48"	26	32	48" x 84"	30" x 30"

Room Darkening & Blackout	Price Group	Page		Sunset Arch	Price Group	Page	Trapezoid	Octagon
Verona 3/4"	23	31	Maximum Width & Length	60" x 60"	27	33	48" x 72"	48" x 48"
Boutique 3/4"				60" x 60"			48" x 72"	48" x 48"
Linen Weave 3/4"				60" x 60"			48" x 72"	48" x 48"
Premiere 1/2"				60" x 60"			48" x 72"	48" x 48"
Premiere 3/4"				60" x 60"			48" x 72"	48" x 48"
Symphony 3/8"				NA			60" x 72"	48" x 48"
Prelude 3/4"	24	31	Max Width & Length	84" x 48"	28	33	48" x 72"	30" x 30"

	Sunset Arch	Trapezoid	Octagon
More Information On Page	Page 67	Page 71	Page 71

*Starburst Movable Arches are available as inside mount only.
 **Through our maximum width is 84" and our maximum is 72" on Sunset Arches, there are limitations on some larger sizes due to excessive weight. If the Sunset width exceeds 66", the maximum length is 60". If the Sunset width exceeds 72", the maximum length is 48".

Speciality Shaped Shades

PRICING

LIGHT FILTERING FABRICS

Boutique 3/4"
 Debut 1/2" Single Cell
 Debut 1/2" Double Cell
 Debut 3/4" Single Cell
 Linen Weave 3/4"

Premiere 1/2"
 Premiere 3/4"
 Symphony 3/8"
 Verona 3/4"

PRICE GROUP 17

Starburst Arches
 Quarter Rounds



For widths wider than 58"

Width In Inches

	24	30	36	42	48	54	60	66	72	78	84	90	96
Non-Movable Starburst	262	298	339	386	462	530	598	675	760	850	944	1047	1164
Movable Starburst	371	420	479	541	647	725	816	913	1019				
Non-Movable Quarter Rounds	339	386	440	502	571	649							
Movable Quarter Rounds	462	524	596	672	760								

Product Information: All fabrics are not available in all widths, lengths and hardware options. Refer to Size Specifications on page 26 and 27 for availability. See pages 66 and 69-70 for detailed information. Templates required on non-perfect non-movable Starburst Arches and Quarter Rounds. Movable Starburst Arch shades are for inside and shallow mount applications only.

Prelude 3/4" Light Filtering

PRICE GROUP 18

Starburst Arches
 Quarter Rounds

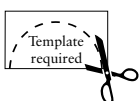

For widths wider than 58"

Width In Inches

	24	30	36	42	48	54	60	66	72	78	84
Stationary Starburst	236	269	306	348	416	477	539	608	684	765	850
Movable Starburst	334	378	432	487	583	653	735	822	918	1010	1111
Stationary Quarter Round	307	350	398	453							
Movable Quarter Round	NOT AVAILABLE										

FABRIC SURCHARGES		ADD
Scotchgard Stain Protector		\$38
Debut 1/2" Single Cell Print Fabric	Includes: Homespun, Country Woven, Florance, Strata, Angel Hair, Blossom, Terrazzo and Strie	20%
Debut 1/2" Double Cell Print Fabric Debut 3/4" Single Cell Print Fabric	Includes: Homespun, Country Woven, Florance, Strata and Angel Hair	20%
Premiere Fabric	Includes: Homespun, Country Woven, Florance, Spheres, Strata, Tuscan Scroll, Angel Hair, Blossom, and Gradients	20%
Symphony Fabric	Symphony Prints and Duotones	20%
	Symphony Double Cell Flame Resistant	30%
PRICING INFORMATION		
Starburst Arches	Price according to the largest radius measurement. If the height is greater than the width, take height X 2 and use that number to determine pricing. Metallic rails available.	
Quarter Rounds	Price according to the largest radius measurement.	
HARDWARE UPGRADE SURCHARGES* AND ACCESSORIES		ADD
6 Foot Expandable Pole		\$44
12 Foot Expandable Pole		\$54

Speciality Shaped Shades
PRICING

ROOM DARKENING & BLACKOUT FABRICS

Boutique 3/4" Premiere 3/4"
Linen Weave 3/4" Symphony 3/8"
Premiere 1/2" Verona 3/4"

PRICE GROUP 19
Starburst Arches
Quarter Round

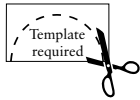

For widths wider than 58"

	Width In Inches												
	24	30	36	42	48	54	60	66	72	78	84	90	96
Non-Movable Starburst	341	387	441	502	601	689	777	878	988	1105	1227	1361	1513
Movable Starburst	482	546	623	703	841	943	1061	1187	1325				
Non-Movable Quarter Rounds	441	502	572	653	742	844							
Movable Quarter Rounds	601	681	775	874	988								

Product Information: All fabrics are not available in all widths, lengths and hardware options. Refer to Size Specifications on page 26 and 27 for availability. See pages 66 and 69-70 for detailed information. Templates required on non-perfect non-movable Starburst Arches and Quarter Rounds. Movable Starburst Arch shades are for inside and shallow mount applications only.

Prelude 3/4" Blackout

PRICE GROUP 20
Starburst Arches
Quarter Rounds

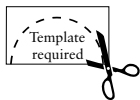

For widths wider than 58"

	Width In Inches										
	24	30	36	42	48	54	60	66	72	78	84
Stationary Starburst	319	364	414	470	562	644	728	821	924	1033	1148
Movable Starburst	451	511	584	658	788	882	993	1110	1240	1364	1500
Stationary Quarter Round	415	473	538	612							
Movable Quarter Round	Not Available										

Product Information: See pages 100 and 103 for detailed information. Templates required on non-perfect non-movable Starburst Arches and Quarter Rounds. Movable Starburst Arch shades are for inside and shallow mount applications only.

FABRIC SURCHARGES		ADD
Scotchgard Stain Protector		\$38
Premiere Fabric	Includes: Homespun, Country Woven, Florance, Spheres, Strata, Tuscan Scroll, Angel Hair, Blossom, and Gradients	20%
PRICING INFORMATION		
Starburst Arches	Price according to the largest radius measurement. If the height is greater than the width, take height X 2 and use that number to determine pricing. Metallic rails available.	
Quarter Rounds	Price according to the largest radius measurement.	
HARDWARE UPGRADE SURCHARGES* AND ACCESSORIES		ADD
6 Foot Expandable Pole		\$44
12 Foot Expandable Pole		\$54

Please note: On the Stationary Starburst Arches when the fabric wrapped hardware is selected, the fabric wrap will be spliced in the center of the base rail.

Speciality Shaped Shades

PRICING

LIGHT FILTERING

Boutique 3/4"

Debut 1/2" Single Cell

Debut 1/2" Double Cell

Debut 3/4" Single Cell

Linen Weave 3/4"

Premiere 1/2"

Premiere 3/4"

Symphony 3/8"

Verona 3/4"

PRICE GROUP 21
Sunset Movable Arches

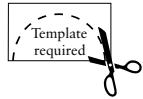

For widths wider than 58"

		Width In Inches										
		24	30	36	42	48	54	60	66	72	78	84
Length In Inches	Half Round	340	378	401	451	481	540	573	630	689	744	821
	36	440	482	506	541	565	606	625	658	689	720	747
	42	464	513	534	587	607	655	676	714	747	786	821
	48	492	541	571	623	646	685	727	766	807	848	893
	60	539	606	636	703	734	797	830	879	927	979	1027
72	592	665	705	782	821	895	939	992	1054	1105	1165	

Product Information: All fabrics are not available in all widths, lengths and hardware options. Refer to Size Specifications on page 27 for availability. See pages 67-68 for detailed information. Templates required on non-perfect Sunset Arches.

Prelude 3/4" Light Filtering

PRICE GROUP 22
Sunset Movable Arches

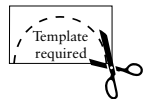

For widths wider than 58"

		Width In Inches										
		24	30	36	42	48	54	60	66	72	78	84
Length In Inches	Half Round	306	341	361	406	433	486	516	567	621	670	739
	36	396	434	456	487	509	546	563	593	621	648	673
	42	418	462	481	529	547	590	609	643	673	708	739
	48	443	487	514	561	582	617	655	690	727	764	804

FABRIC SURCHARGES		ADD
Scotchgard Stain Protector		\$38
Debut 1/2" Single Cell Print Fabric	Includes: Homespun, Country Woven, Florance, Strata, Angel Hair, Blossom, Terrazzo and Strie	20%
Debut 1/2" Double Cell Print Fabric Debut 3/4" Single Cell Print Fabric	Includes: Homespun, Country Woven, Florance, Strata and Angel Hair	20%
Premiere Fabric	Includes: Homespun, Country Woven, Florance, Spheres, Strata, Tuscan Scroll, Angel Hair, Blossom, and Gradients	20%
Symphony Fabric	Symphony Prints and Duotones	20%
	Symphony Double Cell Flame Resistant	30%
HARDWARE UPGRADE SURCHARGES AND ACCESSORIES		ADD
6 Foot Expandable Pole		\$44
12 Foot Expandable Pole		\$54

Speciality Shaped Shades
PRICING

ROOM DARKENING & BLACKOUT FABRICS

Boutique 3/4"
Linen Weave 3/4"
Premiere 1/2"

Premiere 3/4"
Verona 3/4"

PRICE GROUP 23
Sunset Movable Arches

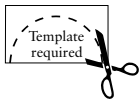

For widths wider than 58"

		Width In Inches						
		24	30	36	42	48	54	60
Length In Inches	Half Round	442	491	521	586	625	702	745
	36	572	627	658	703	735	788	813
	42	603	667	694	763	789	852	879
	48	640	703	742	810	840	891	945
	60	701	788	827	914	954	1036	1079

Product Information: All fabrics are not available in all widths, lengths and hardware options. Refer to Size Specifications on page 27 for availability. See pages 67-68 for detailed information. Templates required on non-perfect Sunset Arches.

Prelude 3/4" Blackout

PRICE GROUP 24
Sunset Movable Arches

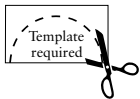

For widths wider than 58"

		Width In Inches										
		24	30	36	42	48	54	60	66	72	78	84
Length In Inches	Half Round	414	461	488	549	585	657	697	766	839	905	998
	36	535	586	616	658	688	738	761	801	839	875	909
	42	565	624	650	715	739	797	823	869	909	956	998
	48	599	658	694	758	786	833	885	932	982	1032	1086

Product Information: See pages 101-102 for detailed information. Templates required on non-perfect Sunset Arches.

FABRIC SURCHARGES		ADD
Scotchgard Stain Protector		\$38
Premiere Fabric	Includes: Homespun, Country Woven, Florance, Spheres, Strata, Tuscan Scroll, Angel Hair, Blossom, and Gradients	20%
HARDWARE UPGRADE SURCHARGES AND ACCESSORIES		ADD
6 Foot Expandable Pole		\$44
12 Foot Expandable Pole		\$54

Speciality Shaped Shades

PRICING

LIGHT FILTERING

Boutique 3/4"

Debut 1/2" Single Cell

Debut 1/2" Double Cell

Debut 3/4" Single Cell

Linen Weave 3/4"

Premiere 1/2"

Premiere 3/4"

Symphony 3/8"

Verona 3/4"

PRICE GROUP 25
Trapezoids and Octagons

Length In Inches	Width In Inches						
	24	30	36	42	48	54	60
36	469	497	532	570	602	634	665
42	486	519	557	598	634	670	709
48	501	540	584	627	665	706	749
54	518	559	607	653	697	743	787
60	536	581	633	681	728	783	830
66	553	602	658	710	764	818	867
72	570	621	681	740	797	854	913

All fabrics are not available in all widths, lengths and applications. Refer to Size Specifications on page 27 for availability.

Product Information: See pages 67-68 for detailed information. Width, length and one side are required measurements for Octagon Shades. **Trapezoid orders must be emailed in with a diagram that includes the measurements for 4 sides.** No templates are required for Trapezoid Shades. * Virtuoso fabrics are available as Octagons only.

Prelude 3/4" Light Filtering

PRICE GROUP 26
Trapezoids and Octagons

Length In Inches	Width In Inches						
	24	30	36	42	48	54	60
36	423	448	479	513	542	571	599
42	438	468	502	539	571	603	639
48	451	486	526	565	599	636	675
54	467	504	547	588	628	669	709
60	483	523	570	613	656	705	747
66	498	542	593	639	688	737	781
72	513	559	613	666	718	769	822

Product Information: See page 104-105 for detailed information. Templates required on all Octagon orders.

FABRIC SURCHARGES		ADD
Scotchgard Stain Protector		\$38
Debut 1/2" Single Cell Print Fabric	Includes: Homespun, Country Woven, Florance, Strata, Angel Hair, Blossom, Terrazzo and Strie	20%
Debut 1/2" Double Cell Print Fabric Debut 3/4" Single Cell Print Fabric	Includes: Homespun, Country Woven, Florance, Strata and Angel Hair	20%
Premiere Fabric	Includes: Homespun, Country Woven, Florance, Spheres, Strata, Tuscan Scroll, Angel Hair, Blossom, and Gradients	20%
Symphony Fabric	Symphony Prints and Duotones	20%
	Symphony Double Cell Flame Resistant	30%
HARDWARE UPGRADE SURCHARGES AND ACCESSORIES		ADD
6 Foot Expandable Pole		\$44
12 Foot Expandable Pole		\$54

Speciality Shaped Shades

PRICING

ROOM DARKENING & BLACKOUT FABRICS

Boutique 3/4"
 Linen Weave 3/4"
 Premiere 1/2"

Premiere 3/4"
 Symphony 3/8"
 Verona 3/4"

PRICE GROUP 27
 Trapezoids and Octagons

		Width In Inches						
		24	30	36	42	48	54	60
Length In Inches	36	610	646	692	741	783	824	865
	42	632	675	724	777	824	871	922
	48	651	702	759	815	865	918	974
	54	673	727	789	849	906	966	1023
	60	697	755	823	885	946	1018	1079
	66	719	783	855	923	993	1063	1127
	72	741	807	885	962	1036	1110	1187

All fabrics are not available in all widths, lengths and applications. Refer to Size Specifications on page 27 for availability.
Product Information: See page 67-68 for detailed information. Templates required on all Octagon orders. Width, length and one side are required measurements for Octagon Shades. **Trapezoid orders must be faxed in with a diagram that includes the measurements for 4 sides.** No templates are required for Trapezoid Shades.

Prelude 3/4" Blackout

PRICE GROUP 28
 Trapezoids and Octagons

		Width In Inches						
		24	30	36	42	48	54	60
Length In Inches	36	572	605	647	693	732	771	809
	42	592	632	678	728	771	815	863
	48	609	657	711	763	809	859	912
	54	631	681	739	794	848	904	958
	60	653	707	770	828	886	952	1009
	66	673	732	801	863	929	995	1055
	72	693	755	828	900	970	1039	1110

Product Information: See page 104-105 for detailed information. Templates required on all Octagon orders. Width, length and one side are required measurements for Octagon Shades. **Trapezoid orders must be faxed in with a diagram that includes the measurements for 4 sides.** No templates are required for Trapezoid Shades.

FABRIC SURCHARGES		ADD
Scotchgard Stain Protector		\$38
Premiere Fabric	Includes: Homespun, Country Woven, Florance, Spheres, Strata, Tuscan Scroll, Angel Hair, Blossom, and Gradients	20%
HARDWARE UPGRADE SURCHARGES AND ACCESSORIES		ADD
6 Foot Expandable Pole		\$44
12 Foot Expandable Pole		\$54

Comfortex Skylight and Greenhouse Shades

SIZE STANDARDS

SPECIALTY SHAPED SHADES

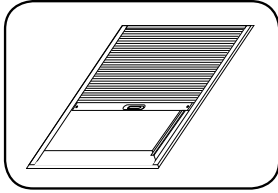

	Minimum	Balcony* 0°-15° 15°-75° 75°-90°**	Soprano*** Skylight/Greenhouse	Mezzo
ALL FABRICS (except ¾" Prelude)	Min Width	15"	11"	18"
	Min Length	12"	11"	12"
Prelude ¾"	Min Width	18"		
	Min Length	12"		

Light Filtering			Balcony			Soprano	Price	Mezzo	Price
	Group		0°-15°	15°-75°	75°-90°	Skylight/ Greenhouse	Group		Group
	Page						Page		Page
Verona ¾"	Grid 30 Page 36	Max Width & Length	NA	NA	NA	NA	Grid 29 Page 35	48" x 72"	Grid 32 Page 45
Boutique ¾"			NA	NA	NA	NA		48" x 72"	
Debut ½" Double			NA	NA	NA	NA		48" x 72"	
Debut ½" Single			36" x 96"	48" x 96"	48" x 72"	36" x 144" SL 29" x 180" GH		48" x 72"	
Debut ¾"			NA	NA	NA	NA		48" x 72"	
Linen Weave ¾"			NA	NA	NA	NA		48" x 72"	
Premiere ½"			NA	NA	NA	NA		48" x 72"	
Premiere ¾"			NA	NA	NA	NA		48" x 72"	
Symphony ¾"			36" x 96"	48" x 96"	48" x 72"	48" x 144" SL 36" x 180" GH		48" x 72"	
Prelude ¾"	Grid 34 Pg 40	Max Width & Length	60" x 72" 25 sq ft						

Room Darkening & Blackout			Balcony			Soprano	Price	Mezzo	Price
	Group		0°-15°	15°-75°	75°-90°	Skylight/ Greenhouse	Group		Group
	Page						Page		Page
Verona ¾"	Grid 31 Page 37	Max Width & Length	NA	NA	NA	NA	Grid 29 Page 35	48" x 72"	Grid 33 Page 39
Boutique ¾"			NA	NA	NA	NA		48" x 72"	
Linen Weave ¾"			NA	NA	NA	NA		48" x 72"	
Premiere ½"			NA	NA	NA	NA		48" x 72"	
Premiere ¾"			NA	NA	NA	NA		48" x 72"	
Symphony ¾"			36" x 96"	48" x 96"	48" x 72"	NA		48" x 72"	
Prelude ¾"	Grid 35 Pg 40		60" x 72" 25 sq ft						

More Information On Page	Page 75	Page 73	Page 77
--------------------------	---------	---------	---------

*Total Balcony shade area not to exceed 24 square feet. **Total Balcony shade area not to exceed 18 square feet. Balcony shades can be mounted on their side. Use vertical measurement as your width (max 36") and the horizontal measurement as your length (max 48"). ***Soprano Skylight minimum installation angle of 5 degrees. Maximum installation angle of 85 degrees. Horizontal (0 degrees) and vertical (90 degrees) applications are not recommended. ***All Soprano Greenhouse shade orders require a completed and signed greenhouse shade order form. Orders must be faxed to Comfortex for processing. Download a copy of the order form at www.comfortex.com/comfortex-dealers.

Comfortex Skylight and Greenhouse Shades

PRICING

SPECIALTY SHAPED SHADES

LIGHT FILTERING FABRICS

Debut 1/2" Single Cell

Symphony 3/8"

PRICE GROUP 29

Soprano Skylights and Greenhouses

		Width In Inches					
		26	30	34	38	42	48
Length In Inches	30	524	559	596	629	664	704
	36	567	607	646	685	724	765
	42	609	656	697	740	785	829
	48	656	704	751	794	842	894
	54	697	754	802	850	899	955
	60	743	802	853	907	957	1018
	72	832	893	955	1017	1078	1148
	84	921	991	1063	1129	1196	1276
	96	1014	1087	1165	1239	1317	1407
	108	1103	1186	1266	1348	1431	1529
	120	1196	1280	1373	1462	1551	1658
132	1283	1379	1476	1572	1670	1783	
144	1365	1477	1581	1686	1787	1914	
156	1453	1574	1686	1796			
168	1539	1674	1790	1906			
180	1623	1774	1892	2016			

All fabrics are not available in all widths, lengths and applications. Refer to Size Specifications on page 34 for availability.

Product Information: See page 73 for detailed information. All greenhouse orders require a completed and signed greenhouse shade order form. Orders must be mailed or faxed to Comfortex for processing. Download a copy at www.comfortex.com or from the OnDemand Mobile Library.

FABRIC SURCHARGES		ADD
Scotchgard Stain Protector		\$38
Debut 1/2" Single Cell Print Fabric	Includes: Homespun, Country Woven, Florance, Strata, Angel Hair, Blossom, Terrazzo and Strie	20%
Symphony Fabric	Symphony Prints and Duotones	20%
	Symphony Double Cell Flame Resistant	30%
HARDWARE UPGRADE SURCHARGES* AND ACCESSORIES		ADD
Two Moving Rails		\$136
6 Foot Expandable Pole		\$44
12 Foot Expandable Pole		\$54

Rail Colors Available:

Please specify when ordering

- White head and bottom rail with white gear track retainer.
- Bronze head and bottom rails and bronze gear track retainer.

Comfortex Skylight and Greenhouse Shades

PRICING

LIGHT FILTERING FABRICS

Debut 1/2" Single Cell

Symphony 3/8"

PRICE GROUP 30 Balcony Skylight Shading System

SPECIALTY SHAPED SHADES

		Width In Inches				
		24	30	36	42	48
Length In Inches	36	335	382	426	477	519
	42	354	406	462	513	570
	48	372	435	490	550	611
	54	398	461	523	584	663
	60	412	488	554	621	711
	66	435	511	583	653	758
	72	461	539	608	681	800
	78	488	559	637	711	
	84	515	586	664	740	
	90	549	608	692		
96	575	634	721			

All fabrics are not available in all widths, lengths and applications. Refer to Size Specifications on page 34 for availability.

Product Information: See page 75 for detailed information.

- Shades are built with color coordinating hardware and white track.
- Designer metallic and fabric wrapped rails are available.

FABRIC SURCHARGES		ADD
Scotchgard Stain Protector		\$38
Debut 1/2" Single Cell Print Fabric	Includes: Homespun, Country Woven, Florance, Strata, Angel Hair, Blossom, Terrazzo and Strie	20%
Symphony Fabric	Symphony Prints and Duotones	20%
	Symphony Double Cell Flame Resistant	30%
HARDWARE UPGRADE SURCHARGES AND ACCESSORIES		ADD
Metallic Hardware or Fabric Wrapped Rails		\$24
6 Foot Expandable Pole		\$44
12 Foot Expandable Pole		\$54

Comfortex Skylight and Greenhouse Shades

PRICING

BLACKOUT FABRICS

Symphony 3/8"

PRICE GROUP 31
Balcony Skylight Shading System

		Width In Inches				
		24	30	36	42	48
Length In Inches	36	436	497	554	620	675
	42	460	528	601	667	741
	48	484	566	637	715	794
	54	517	599	680	759	862
	60	536	634	720	807	924
	66	566	664	758	849	985
	72	599	701	790	885	1040
	78	634	727	828	924	
	84	670	762	863	962	
	90	714	790	900		
96	748	824	937			

- Product Information:** See page 75 for detailed information.
- Shades are built with color coordinating hardware and white track.
 - Designer metallic and fabric wrapped rails are available.

FABRIC SURCHARGES		ADD
Scotchgard Stain Protector		\$38
Debut 1/2" Single Cell Print Fabric	Includes: Homespun, Country Woven, Florance, Strata, Angel Hair, Blossom, Terrazzo and Strie	Add 20%
Symphony Fabric	Symphony Prints and Duotones	Add 20%
	Symphony Double Cell Flame Resistant	Add 30%
HARDWARE UPGRADE SURCHARGES AND ACCESSORIES		ADD
Metallic Hardware or Fabric Wrapped Rails		\$24
6 Foot Expandable Pole		\$44
12 Foot Expandable Pole		\$54

Comfortex Skylight and Greenhouse Shades

PRICING

LIGHT FILTERING FABRICS

Boutique 3/4"
 Debut 1/2" Single Cell
 Debut 1/2" Double Cell
 Debut 3/4" Single Cell
 Linen Weave 3/4"

Premiere 1/2"
 Premiere 3/4"
 Symphony 3/8"
 Verona 3/4"

PRICE GROUP 32
 Mezzo Motorized Skylights -
 White Rail and White Tracks

SPECIALTY SHAPED SHADES

		Width In Inches				
		24	30	36	42	48
Length In Inches	36	418	476	532	597	648
	42	444	507	577	640	712
	48	468	544	613	686	764
	54	496	576	655	730	827
	60	515	608	691	776	888
	66	544	637	727	817	947
72	576	675	760	850	1000	

Be sure to add the Simplicity motor surcharges and upgrades to the grid above. Shades and motors are priced separately to ensure that percent surcharges apply only to the shade and not the motor.

Product Information: See page 77 for detailed information.

- Mezzo Shades are built with white rail and white track.

FABRIC SURCHARGES		ADD
Scotchgard Stain Protector		\$38
Debut 1/2" Single Cell Print Fabric	Includes: Homespun, Country Woven, Florance, Strata, Angel Hair, Blossom, Terrazzo and Strie	20%
Debut 1/2" Double Cell Print Fabric Debut 3/4" Single Cell Print Fabric	Includes: Homespun, Country Woven, Florance, Strata and Angel Hair	20%
Premiere Fabric	Includes: Homespun, Country Woven, Florance, Spheres, Strata, Tuscan Scroll, Angel Hair, Blossom, and Gradients	20%
Symphony Fabric	Symphony Prints and Duotones	20%
	Symphony Double Cell Flame Resistant	30%
MOTORIZATION - HARDWARE UPGRADE SURCHARGES AND ACCESSORIES		MORE INFO
Simplicity - Motor and Rechargeable Battery Pack		Pg 60
Simplicity 5 Channel Remote		Pg 61
Simplicity 6 Channel Remote with Timer		Pg 61
Simplicity 14 Channel White Remote		Pg 58
48" Extension Wire:		Pg 61
Simplicity Smart Controller (NEO)		Pg 59
7.4v Solar Panel & Mounting Brackets		Pg 78
Plug-In Charger for 7.4V Li-Ion Rechargeable Battery Pack		Pg 78
		ADD
		\$368
		\$44
		\$72
		\$72
		\$20
		\$363
		\$110
		\$30

Comfortex Skylight and Greenhouse Shades

PRICING

ROOM DARKENING & BLACKOUT FABRICS

Boutique 3/4"
 Linen Weave 3/4"
 Premiere 1/2"

Premiere 3/4"
 Symphony 3/8"
 Verona 3/4"

PRICE GROUP 33
 Mezzo Motorized Skylights -
 White Rail and White Tracks

		Width In Inches				
		24	30	36	42	48
Length In Inches	36	543	619	692	776	842
	42	577	659	750	832	926
	48	608	707	797	892	993
	54	645	749	852	949	1075
	60	670	790	898	1009	1154
	66	707	828	945	1062	1231
	72	749	878	988	1105	1300

Be sure to add the Simplicity motor surcharges and upgrades to the grid above.

Product Information: See page 77 for detailed information.

- Mezzo Shades are built with white rail and white track.

FABRIC SURCHARGES		ADD	
Scotchgard Stain Protector		\$38	
Premiere Fabric	Includes: Homespun, Country Woven, Florance, Spheres, Strata, Tuscan Scroll, Angel Hair, Blossom, and Gradients	Add 20%	
MOTORIZATION - HARDWARE UPGRADE SURCHARGES AND ACCESSORIES		MORE INFO	ADD
Simplicity - Motor and Rechargeable Battery Pack		Pg 60	\$368
Simplicity 5 Channel Remote		Pg 61	\$44
Simplicity 6 Channel Remote with Timer		Pg 61	\$72
Simplicity 14 Channel White Remote		Pg 58	\$72
48" Extension Wire:		Pg 61	\$20
Simplicity Smart Controller (NEO)		Pg 59	\$363
7.4v Solar Panel & Mounting Brackets		Pg 78	\$110
Plug-In Charger for 7.4V Li-Ion Rechargeable Battery Pack		Pg 78	\$30

Comfortex Skylight and Greenhouse Shades

PRICING

Prelude 3/4" Light Filtering

**PRICE GROUP 34
Skylight Shading System**

		Width In Inches						
		24	30	36	42	48	54	60
Length In Inches	36	302	344	384	430	468	539	620
	42	319	366	416	462	513	590	679
	48	335	392	441	495	550	633	728
	54	359	415	471	526	597	687	791
	60	371	440	499	559	640	736	847
	66	392	460	525	588	683	786	904
	72	415	486	548	613	720	828	953

Prelude 3/4" Blackout

**PRICE GROUP 35
Skylight Shading System**

		Width In Inches						
		24	30	36	42	48	54	60
Length In Inches	36	408	465	519	581	632	728	837
	42	431	495	562	624	693	797	917
	48	453	530	596	669	743	855	983
	54	485	561	636	711	806	928	1068
	60	501	594	674	755	864	994	1144
	66	530	621	709	794	923	1062	1221
	72	561	657	740	828	972	1118	1287

Product Information: See page 106 for detailed information.

HARDWARE UPGRADE SURCHARGES AND ACCESSORIES		ADD
6 Foot Expandable Pole		\$44

French Door Décor Shades
SIZE STANDARDS

SPECIALTY SHAPED SHADES

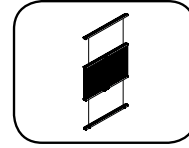
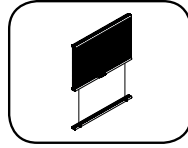
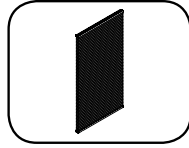

		Door Decor Non-Movable	Door Decor Movable		Door Decor Top Down-Bottom Up
ALL FABRICS	Minimum Width	6"	6"		6"
	Minimum Length	12"	12"		12"

Light Filtering	Price Group	Page		Door Decor Non-Movable	Door Decor Movable	Price Group Page	Door Decor Top Down-Bottom Up	Price Group Page
Verona 3/4"	36	41	Maximum Width & Length	36" x 96"	36" x 96"	37 Page 43	36" x 96"	37 Page 43
Boutique 3/4"				36" x 96"	36" x 96"		36" x 96"	
Debut 1/2" Single				36" x 96"	36" x 96"		36" x 96"	
Debut 1/2" Double				36" x 96"	36" x 96"		36" x 96"	
Debut 3/4"				36" x 96"	36" x 96"		36" x 96"	
Linen Weave 3/4"				36" x 96"	36" x 96"		36" x 96"	
Premiere 1/2"				36" x 96"	36" x 96"		36" x 96"	
Premiere 3/4"				36" x 96"	36" x 96"		36" x 96"	
Symphony 3/8"				36" x 96"	36" x 96"		36" x 96"	

Room Darkening & Blackout	Price Group Page	Page		Door Decor Non-Movable	Door Decor Movable	Price Group Page	Door Decor Top Down-Bottom Up	Price Group Page
Verona 3/4"	38	44	Maximum Width & Length	36" x 96"	36" x 96"	39 Page 45	36" x 96"	39 Page 45
Boutique 3/4"				36" x 96"	36" x 96"		36" x 96"	
Linen Weave 3/4"				36" x 96"	36" x 96"		36" x 96"	
Premiere 1/2"				36" x 96"	36" x 96"		36" x 96"	
Premiere 3/4"				36" x 96"	36" x 96"		36" x 96"	
Symphony 3/8"				36" x 96"	36" x 96"		36" x 96"	

	Door Decor Non-Movable	Door Decor Movable	Door Decor Top Down-Bottom Up
More Information On Page	Page 80	Page 80	Page 80

French Door Décor Shades

PRICING

LIGHT FILTERING FABRICS

- Boutique ³/₄"
- Debut ¹/₂" Single Cell
- Debut ¹/₂" Double Cell
- Debut ³/₄" Single Cell
- Linen Weave ³/₄"
- Premiere ¹/₂"
- Premiere ³/₄"
- Symphony ³/₈"
- Verona ³/₄"

PRICE GROUP 36
Non-Movable French Door Décor

SPECIALTY SHAPED SHADES

		Width In Inches		
		24	30	36
Length In Inches	36	108	121	138
	42	115	132	147
	48	122	141	161
	54	130	149	173
	60	139	160	183
	66	146	171	197
	72	153	178	207
	78	161	188	217
	84	167	198	228
	90	175	206	239
96	180	214	250	

Product Information: See page 80 for detailed information.

FABRIC SURCHARGES		ADD
Scotchgard Stain Protector		\$38
Debut ¹ / ₂ " Single Cell Print Fabric	Includes: Honespun, Country Woven, Florance, Strata, Angel Hair, Blossom, Terrazzo and Strie	20%
Premiere Fabric	Includes: Honespun, Country Woven, Florance, Spheres, Strata, Tuscan Scroll, Angel Hair, Blossom, and Gradients	20%
Symphony Fabric	Symphony Prints and Duotones	20%
	Symphony Double Cell Flame Resistant	30%
HARDWARE UPGRADE SURCHARGES AND ACCESSORIES		ADD
Metallic Hardware or Fabric Wrapped Rails		\$24
6 Foot Expandable Pole		\$44
12 Foot Expandable Pole		\$54

French Door Décor Shades
PRICING

LIGHT FILTERING FABRICS

Boutique 3/4"
Debut 1/2" Single Cell
Debut 1/2" Double Cell
Debut 3/4" Single Cell
Linen Weave 3/4"

Premiere 1/2"
Premiere 3/4"
Symphony 3/8"
Verona 3/4"

PRICE GROUP 37
Movable French Door Décor

		Width In Inches		
		24	30	36
Length In Inches	36	193	217	247
	42	207	236	267
	48	220	254	289
	54	234	269	309
	60	250	287	332
	66	264	305	353
	72	277	322	372
	78	289	340	392
	84	300	354	411
	90	315	370	431
96	326	385	449	

Product Information: See page 80 for detailed information.

FABRIC SURCHARGES		ADD
Scotchgard Stain Protector		\$38
Debut 1/2" Single Cell Print Fabric	Includes: Homespun, Country Woven, Florance, Strata, Angel Hair, Blossom, Terrazzo and Strie	20%
Premiere Fabric	Includes: Homespun, Country Woven, Florance, Spheres, Strata, Tuscan Scroll, Angel Hair, Blossom, and Gradients	20%
Symphony Fabric	Symphony Prints and Duotones	20%
	Symphony Double Cell Flame Resistant	30%
HARDWARE UPGRADE SURCHARGES AND ACCESSORIES		ADD
Top Down-Bottom Up		\$589
Metallic Hardware or Fabric Wrapped Rails		\$24
6 Foot Expandable Pole		\$44
12 Foot Expandable Pole		\$54

French Door Décor Shades

PRICING

ROOM DARKENING & BLACKOUT FABRICS

Boutique 3/4"
 Linen Weave 3/4"
 Premiere 1/2"

Premiere 3/4"
 Symphony 3/8"
 Verona 3/4"

PRICE GROUP 38
 Non-Movable French Door Décor

SPECIALTY SHAPED SHADES

		Width In Inches		
		24	30	36
Length In Inches	36	140	157	179
	42	150	172	191
	48	159	183	209
	54	169	194	225
	60	181	208	238
	66	190	222	256
	72	199	231	269
	78	209	244	282
	84	217	257	296
	90	228	268	311
96	234	278	325	

Product Information: See page 80 for detailed information.

FABRIC SURCHARGES		ADD
Scotchgard Stain Protector		\$38
Premiere Fabric	Includes: Honespun, Country Woven, Florance, Spheres, Strata, Tuscan Scroll, Angel Hair, Blossom, and Gradients	20%
Symphony Fabric	Symphony Prints and Duotones	20%
	Symphony Double Cell Flame Resistant	30%
HARDWARE UPGRADE SURCHARGES AND ACCESSORIES		ADD
Metallic Hardware or Fabric Wrapped Rails		\$24
6 Foot Expandable Pole		\$44
12 Foot Expandable Pole		\$54

French Door Décor Shades

PRICING

ROOM DARKENING & BLACKOUT FABRICS

Boutique 3/4"
 Linen Weave 3/4"
 Premiere 1/2"

Premiere 3/4"
 Symphony 3/8"
 Verona 3/4"

PRICE GROUP 39
Movable French Door Décor

SPECIALTY SHAPED SHADES

		Width In Inches		
		24	30	36
Length In Inches	36	251	282	321
	42	269	307	347
	48	286	330	376
	54	304	350	402
	60	325	373	432
	66	343	397	459
	72	360	419	484
	78	376	442	510
	84	390	460	534
	90	410	481	560
96	424	501	584	

Product Information: See page 80 for detailed information.

FABRIC SURCHARGES		ADD
Scotchgard Stain Protector		\$38
Premiere Fabric	Includes: Homespun, Country Woven, Florance, Spheres, Strata, Tuscan Scroll, Angel Hair, Blossom, and Gradients	20%
Symphony Fabric	Symphony Prints and Duotones	20%
	Symphony Double Cell Flame Resistant	30%
HARDWARE UPGRADE SURCHARGES AND ACCESSORIES		ADD
Top Down-Bottom Up		\$589
Metallic Hardware or Fabric Wrapped Rails		\$24
6 Foot Expandable Pole		\$44
12 Foot Expandable Pole		\$54

Cellular Shade Collection
STANDARD CORD LOCK SHADES HARDWARE SYSTEM

Prelude Hardware Page 85

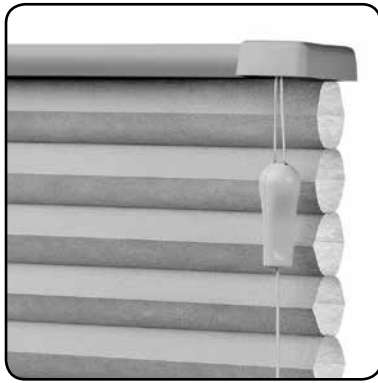

Standard Cord Lock Rail

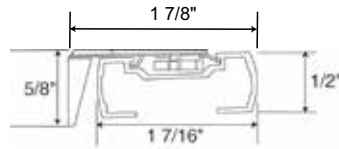

Deluxe Cord Lock Rail

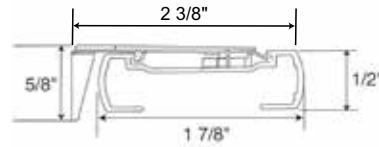

Standard Cord Lock Rail

- Depth of rail: 1 7/16"
- Depth of rail and bracket: 1 7/8"
- Height of rail: 1/2"
- Height of bracket: 5/8"

Deluxe Cord Lock Rail

- Depth of rail: 1 7/8"
- Depth of rail and bracket: 2 3/8"
- Height: 1/2"
- Height of bracket: 5/8"

CELLULAR HARDWARE

Hardware Features	
Hardware colors for all Cellular fabrics	Color coordinated head and bottom rails with white cord and tassel
Standard Hardware for all Custom Graphics	White head and bottom rails with white cord and tassel
Upgrades	
Fabric Wrapped Upgrade	Fabric used is same fabric as the shade. Back of rail is white to outside. Color coordinated end caps.
Designer Metallic Upgrade	<ul style="list-style-type: none"> • Oil Rubbed Bronze head and bottom rails, bronze colored tassel, bronze end caps and white cord. • Brushed Nickel head and bottom rails and end caps with white cord.

Mounting Dimensions	Standard Cord Lock Rail	Deluxe Cord Lock Rail
Minimum Shallow Mount	3/4"	3/4"
Minimum Flush Inside Mount	2"	2 3/8"
Minimum Outside Mount	3/4"	3/4"
Minimum Side Mount	1 1/8"	1 3/8"
Minimum Flush Side Mount	1 5/8"	1 7/8"
Recommended Side Mounting Method	<ul style="list-style-type: none"> • See figure B for recommended mounting method for side mount shades • Width limit for side mount brackets is 48" 	

Finished Dimensions	
Inside and Side Mount	
	<ul style="list-style-type: none"> • Fabric will measure ordered width less: 3/8" • Head rail* will measure ordered width less: 3/16"
Outside Mount	
	<ul style="list-style-type: none"> • Fabric will measure ordered width • Head rail* will measure ordered width plus: 3/16"
Exact (End Cap to End Cap) Mount	
	<ul style="list-style-type: none"> • Fabric will measure ordered width less: 3/16" • Head rail* will measure ordered width
Cord Length	
	<ul style="list-style-type: none"> • Comfortex complies with all WCMA/ANSI standards and as such the default cord length will be 40% of the ordered shade length. Custom lengths are available.
* Head rail measurements include endcaps. Width and length measurements may vary +/- 1/8"	

Cellular Shade Collection

STANDARD CORD LOCK SHADES HARDWARE SYSTEM

Prelude Hardware Page 85

There are two sizes of the cord lock hardware: Standard and Deluxe.

Standard size hardware is used on all fabrics except ¾" Premiere, Linen Weave, Debut, Verona and Boutique Fabrics which use the Deluxe size.

- Standard Rectangular
- Two-On-One Head Rail
- Door Decor
- SlumberShades
- Top Down - Bottom Up
- Day-Night
- Specialty Shapes
- Balcony

Deluxe Hardware is standard on ¾" Premiere, Linen Weave, Debut, Verona and Boutique Fabrics.

- Standard Rectangular
- SlumberShades
- Two-On-One Head Rail
- Top Down - Bottom Up
- Specialty Shapes

Highlights Cornice Valance

Add a designer finishing touch to a cellular shade with a Highlights Cornice Valance. See page 107 for details.

Recommended Mounting Method for Side Mount Shades | Maximum Width 48"

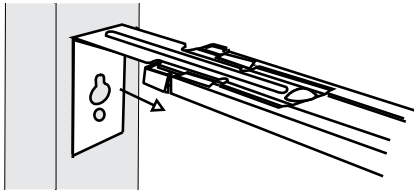

Figure B

EZ Level on Cellular Shades

EZ Level makes quick work of leveling without cords to cut or tuck into a rail. See page 116 for details.

Things to Consider

- If child safety is a concern, consider cordless options: Cordless Ultra, Cordless Lift & Lock or Motorization.
- Larger shades can be difficult to operate. Consider Cord Loop, Cordless Ultra or Motorization hardware.
- If privacy is an issue, consider Top Down-Bottom Up options.

Ordering Information Standard Cord Lock Shades

Standard Rectangular

- Specify IB or OB mount, rail color and left or right lift cord.

Top Down - Bottom Up

- Specify IB or OB mount and rail color. Middle rail will match the head and bottom rails.
- Top Down - Bottom Up Shades are made with two operating cord locks, one on the left and one on the right side of shade. The right cord operates the middle rail and left cord operates the bottom.

Two-On-One Head Rail

Two-On-One Head Rail Shades operate as two separate shades on one head rail.

- Specify IB or OB mount.
- Specify panel sizes.
- Maximum width in a single panel depends on fabric type. See page 11 for maximum single panel width.
- ⅜" Space between panels.
- Fabric wrapped Two-On-One Shades will have a seam in the center of the rail due to the wide width.

Specialties (Arches, Trapezoids, Octagons and Quarter Rounds)

See pages 66-72 for more information.

Balcony Skylight Shading System

See pages 75-76 for more information.

Door Decor

See pages 80-81 for more information.

Insulating SlumberShades

See pages 64-65 for more information.

Day-Night Shades

See pages 82-83 for more information.

Cellular Shade Collection
CORD LOOP HARDWARE SYSTEM

Prelude Hardware Page 87

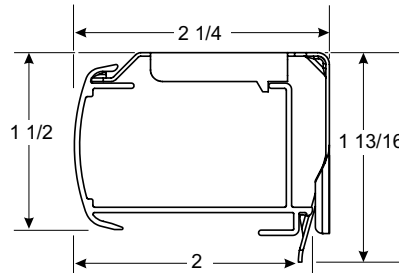

Cord Loop Rail Dimensions

- Depth of rail: 2"
- Depth of rail and bracket: 2 1/4"
- Height of rail: 1 1/2"
- Height of bracket: 1 13/16"

CELLULAR HARDWARE

Hardware Features	
Hardware colors for all Cellular and Pleated fabrics	Color coordinated head, bottom rails and end caps with a white cord and tensioner
Standard Hardware for all Custom Graphics	White head and bottom rails with white cord
Upgrades	
Fabric Wrapped Upgrade	Fabric used is same fabric as the shade. Back of rail is white to outside. Color coordinated end caps for bottom rails, head rail has white clutch cover and end caps.
Designer Metallic Upgrade	<ul style="list-style-type: none"> • Smooth faced Oil Rubbed Bronze head, bottom rails and end caps with bronze tensioner and bronze cord. • Smooth faced Brushed Nickel head, bottom rails and end caps with silver tensioner and silver cord.

Mounting Dimensions	Cord Loop Hardware System
Minimum Shallow Mount	1/2"
Minimum Flush Inside Mount	2 1/4"
Minimum Outside Mount	7/8"
Minimum Side Mount	1 1/4"
Minimum Flush Side Mount	2 1/4"
Recommended Side Mounting Method	<ul style="list-style-type: none"> • See figure A for recommended mounting method for side mount shades • Width limit for side mount brackets is 48"

Finished Dimensions	
Inside Mount	
	<ul style="list-style-type: none"> • Fabric will measure ordered width less: 3/8" • Head rail* will measure ordered width less: 3/16"
Outside Mount	
	<ul style="list-style-type: none"> • Fabric will measure ordered width • Head rail* will measure ordered width plus: 3/16"
Side Mount	
	<ul style="list-style-type: none"> • Fabric will measure ordered width less: 7/8" • Head rail* will measure ordered width less: 1 1/16"
Exact (End Cap to End Cap) Mount	
	<ul style="list-style-type: none"> • Fabric will measure ordered width less: 3/16" • Head rail* will measure ordered width

* Head rail measurements include endcaps. Width and length measurements may vary +/- 1/8"

Cellular Shade Collection

CORD LOOP HARDWARE SYSTEM

Prelude Hardware Page 87

Applications

- Standard Rectangular
- Two-On-One Head Rail
- Top Down - Bottom Up
- SlumberShades

Cord Loop Hardware System Features

Cord loops are available 2' to 15' lengths in 1' intervals. Please specify length when ordering. Standard loop sizes are as follows:

Shade Length	Standard Loop
Up to and including 26 ⁷ / ₈ "	1' (12")
27" to 39 ⁷ / ₈ "	2' (24")
40" to 59 ⁷ / ₈ "	3' (36")
60" to 83 ⁷ / ₈ "	4' (48")
84" to 107 ⁷ / ₈ "	5' (60")
108" and greater	6' (72")

Recommended Mounting Method for Side Mounting Shades

Width limit for side mount brackets is 48".

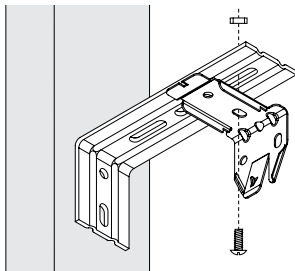

Cord Loop Hardware
Cordless Ultra Hardware
Cordless Ultra Top Down - Bottom Up Hardware

Figure A

Refer to the installation instructions on Comfortex.com/comfortex-dealers or the OnDemand Mobile Library for further details on side mounting shades.

Ordering Information for Cord Loop Hardware Shades

Standard Rectangular

- Specify IB or OB mount, rail color and left or right loop cord.
- Specify cord loop length when ordering.

Top Down - Bottom Up

- Specify IB or OB mount and rail color. Middle rail will match the top and bottom rails.
- Specify cord loop length when ordering.
- Controls are the right cord loop operates the middle rail and left cord loop operates the bottom. Reverse controls are not available.

Two-On-One Head Rail

- Two-On-One Head Rail Shades operate as two separate shades on one head rail.
- Specify IB or OB mount and rail color.
- Specify panel sizes.
- Specify cord loop length when ordering.
- Maximum width in a single panel depends on fabric type. See page 5 for maximum single panel width.
- ³/₈" Space between panels.
- Fabric wrapped Two-On-One Shades will have a seam in the center of the rail due to the wide width.

Insulating SlumberShades

See pages 64-65 for more information.

EZ Level on Cellular Shades

EZ Level makes quick work of leveling without cords to cut or tuck into a rail. See page 116 for details.

Cellular Shade Collection

CORDLESS ULTRA HARDWARE SYSTEM

Prelude Hardware Page 89

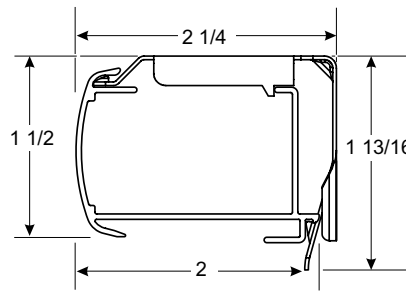

Cord Loop Rail Dimensions

- Depth of rail: 2"
- Depth of rail and bracket: 2 1/4"
- Height of rail: 1 1/2"
- Height of bracket: 1 13/16"

CELLULAR HARDWARE

Hardware Features	
Hardware colors for all Cellular fabrics (Symphony Blackout Not Available)	Color coordinated head, bottom rails and end caps
Standard Hardware for all Custom Graphics	White head, bottom rails and end caps
Upgrades	
Fabric Wrapped Upgrade	Fabric used is same fabric as the shade. Back of rail is white to outside. End caps on fabric wrapped head and bottom rails are color coordinated
Designer Metallic Upgrade	<ul style="list-style-type: none"> • Smooth faced Oil Rubbed Bronze head, bottom rails and end caps • Smooth faced Brushed Nickel head, bottom rails and end caps
Mounting Dimensions	Cord Loop Hardware System
Minimum Shallow Mount	1/2"
Minimum Flush Inside Mount	2 1/4"
Minimum Outside Mount	7/8"
Minimum Side Mount	1 1/4"
Minimum Flush Side Mount	2 1/4"
Recommended Side Mounting Method	<ul style="list-style-type: none"> • See figure A on page 49 for recommended mounting method for side mount shades • Width limit for side mount brackets is 48"
Finished Dimensions	
Inside Mount	
	<ul style="list-style-type: none"> • Fabric will measure ordered width less: 3/8" • Head rail* will measure ordered width less: 3/16"
Outside Mount	
	<ul style="list-style-type: none"> • Fabric will measure ordered width • Head rail* will measure ordered width plus: 3/16"
Side Mount	
	<ul style="list-style-type: none"> • Fabric will measure ordered width less: 7/8" • Head rail* will measure ordered width less: 1 1/16"
Exact (End Cap to End Cap) Mount	
	<ul style="list-style-type: none"> • Fabric will measure ordered width less: 3/16" • Head rail* will measure ordered width
* Head rail measurements include endcaps. Width and length measurements may vary +/- 1/8"	

Cellular Shade Collection

CORDLESS ULTRA HARDWARE SYSTEM

Prelude Hardware Page 89

Applications

- Standard Rectangular
- Top Down - Bottom Up
- Insulating SlumberShades
- Two-On-One Head Rail

Highlights Cornice Valance

Add a designer finishing touch to a cellular shade with a Highlights Cornice Valance. See page 107 for details.

Things to Consider

- Is the top of your window out of reach? You can order an extension pole to reach but it can still be tricky. You may want to consider Cord Loop or Motorized hardware.
- For shades mounted on doors, you may want to order hold down brackets.
- If privacy is an issue, consider Top Down-Bottom Up options.

Ordering Information for Cordless Ultra Hardware Shades

Standard Rectangular

- Specify IB or OB mount and rail color.

Top Down - Bottom Up

- Specify IB or OB mount and rail color. Middle rail will match the head and bottom rails.

Insulating SlumberShades

See pages 64-65 for more information.

Accessories

- 6' Expandable Pole:
- 12' Expandable Pole:

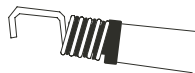

Specially designed pole end fits into the handle on the bottom rail and allows for easy operation.

Cordless Ultra and Cordless Ultra Top Down - Bottom Up Hardware Features

- Children and pets have safer surroundings in homes that have window shades without operating cords, reducing the risk of strangulation.
- Cordless Ultra and Cordless Ultra Top Down - Bottom Up Shades can be raised or lowered with a gentle push or pull on the rail handle.
- Cordless Ultra Top Down - Bottom Up Shades feature two moving rails.
- Order an operating pole for out of reach applications.

Cordless Ultra Shade Operation

Cordless shades should be operated from the handle located in the center of the bottom rail. Using the handle will aid in smooth and easy shade operation. Two handles are supplied on wider width shades.

To lower the shade, pull down on the handle which is secured to the bottom rail and guide the rail to desired position (Figure A). For out of reach applications, an optional extension pole should be used.

To raise the shade, push the bottom rail up using the handle on the bottom rail and guide the rail to the desired position. The shade will hold any position when the bottom rail is released. Raise the shade slowly and steadily to allow the shade to stack evenly (Figure B).

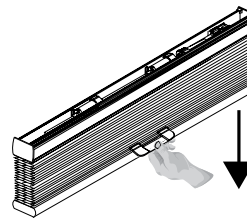

Figure A

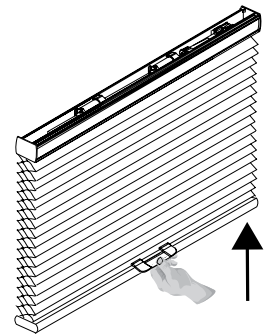

Figure B



Clear Cordless Handle

Recommended Mounting Method for Side Mounting Shades

See Page 49.

EZ Level on Cellular Shades

EZ Level makes quick work of leveling without cords to cut or tuck into a rail. See page 116 for details.

Simplicity Motorization Pricing Example:	
Linen Weave	
Light Filtering 42" x 60" Shade:	\$383.00
Cordless Ultra Surcharge:	\$88.00
Scotchgard:	\$38.00
Total List Price:	\$509.00

CELLULAR HARDWARE

Cellular Shade Collection

CORDLESS LIFT & LOCK HARDWARE SYSTEM

Prelude Hardware Page 91



Standard Head Rail

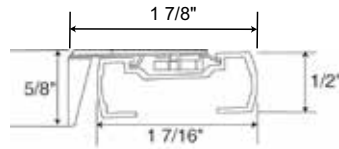

Deluxe Head Rail

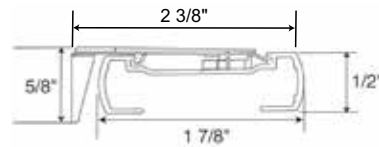

Standard Top Rail

- Depth of rail: 1 7/16"
- Depth of rail and bracket: 1 7/8"
- Height of rail: 1/2"
- Height of bracket: 5/8"

Deluxe Top Rail

- Depth of rail: 1 7/8"
- Depth of rail and bracket: 2 3/8"
- Height: 1/2"
- Height of bracket: 5/8"

Hardware Features

Hardware colors for all Cellular fabrics	Color coordinated head, middle and bottom rails with color coordinated push button/handle on the middle and bottom rails
Standard Hardware for all Custom Graphics	White head, middle and bottom rails with white cord

Upgrades

Fabric Wrapped Upgrade	Fabric used is same fabric as the shade. Back of rail is white to outside. All shades will have a color coordinated push button and handle on the middle /bottom rail. Color coordinated end caps.
Designer Metallic Upgrade	<ul style="list-style-type: none"> • Oil Rubbed Bronze head, middle, bottom rails and end caps. • Oil Rubbed Bronze push button/handle on the middle and bottom rails.

Mounting Dimensions

	Standard Head Rail	Deluxe Head Rail
Minimum Shallow Mount	3/4"	3/4"
Minimum Flush Inside Mount	2"	2 1/2"
Minimum Outside Mount	3/4"	3/4"
Minimum Side Mount	1 1/8"	1 3/8"
Minimum Flush Side Mount	1 5/8"	1 7/8"

Recommended Side Mounting Method

- See figure A (pg 49) for recommended mounting method for side mount shades
- Width limit for side mount brackets is 48"

Finished Dimensions

Inside and Side Mount

- Fabric will measure ordered width less: 3/8"
- Head rail* will measure ordered width less: 3/16"

Outside Mount

- Fabric will measure ordered width
- Head rail* will measure ordered width plus: 3/16"

Exact (End Cap to End Cap) Mount

- Fabric will measure ordered width less: 3/16"
- Head rail* will measure ordered width

* Head rail measurements include endcaps. Width and length measurements may vary +/- 1/8"

CELLULAR HARDWARE

Cellular Shade Collection

CORDLESS LIFT & LOCK HARDWARE SYSTEM

Prelude Hardware Page 91

Cordless Lift & Lock Shades Hardware System Bottom Rail Dimensions

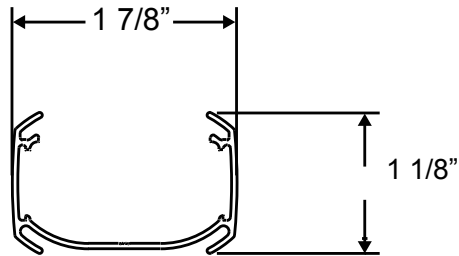

- Depth of rail: 1 7/8"
- Height of rail: 1 1/8"

Applications

- Standard Rectangular
- Top Down-Bottom Up
- Two-On-One Headrail

Standard size head rail hardware is used on 1/2" and 3/8" fabrics. These fabrics include: 1/2" Debut (all), 1/2" Premiere, Symphony, and Symphony Blackout.

Deluxe size head rail hardware is used on 3/4" Premiere, Linen Weave, Verona, Boutique and 3/4" Debut.

The bottom rail is the same size for all fabrics.

- Two-On-One headrail price as 2 separate shades and add \$52 (not available in Top Down-Bottom Up)

Highlights Cornice Valance

Add a designer finishing touch to a cellular shade with a Highlights Cornice Valance. See page 107 for details.

Important Operating Note on Cordless Lift & Lock Shades

- To operate a Cordless Lift & Lock Shade, the middle or bottom rails must be accessible. An extension pole is not available for Cordless Lift & Lock Shades.

Cordless Lift & Lock Hardware Features

- Children and pets have safer surroundings in homes that have window shades without operating cords, reducing the risk of strangulation.
- Cordless Lift & Lock Shades can be raised or lowered by pressing the button located on the bottom rail and guiding the rail into the desired location.

Leveling the Bottom Rails

Each Cordless Lift & Lock Shade includes a skew adjustment leveling tool hidden in the bottom rail of each shade.

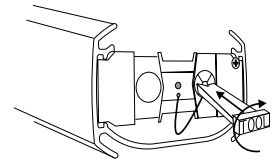

To level the bottom rail, remove the bottom rail end cap to access the tool which allows you to adjust the bottom rail. Adjustment instructions are supplied with each shade.

Things to Consider

- Is the top of your window out of reach? To operate a Cordless Lift & Lock Shade, the bottom rail must be accessible. If the bottom or middle rail is not accessible, you may want to consider Cord Loop, Cordless Ultra or Motorized hardware. An extension pole is not available for Cordless Lift & Lock Shades.
- For shades mounted on doors, you may want to order hold down brackets.

Ordering Information for Cordless Lift & Lock Shades

Standard Rectangular

- Specify IB or OB mount and rail color.

Cordless Lift & Lock Shade Operation

Cordless Lift & Lock Shades are operated using the push button handle located in the center of the bottom rail.

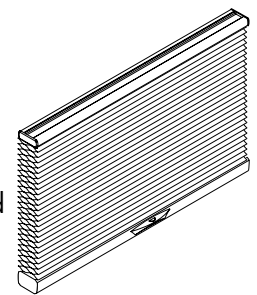

To raise or lower the shade; press the button on the shade handle, and guide the rail to desired position. Release the button to lock the shade into place.

The shade will hold any position when the button is released. Raise the shade slowly and steadily to allow the shade to stack evenly.

Cellular Shade Collection

RECHARGEABLE SIMPLICITY MOTORIZED HARDWARE SYSTEM

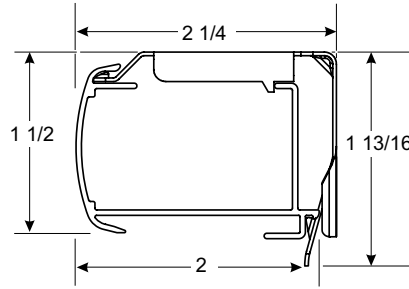

Rechargeable Simplicity Rail Dimensions

- Depth of rail: 2"
- Depth of rail and bracket: 2 1/4"
- Height of rail: 1 1/2"
- Height of bracket: 1 13/16"

CELLULAR HARDWARE

Hardware Features	
Hardware colors for all Cellular fabrics	Color coordinated head, bottom rails and end caps
Standard Hardware for all Custom Graphics	White head and bottom rails and end caps
Upgrades	
Fabric Wrapped Upgrade	Fabric used is same fabric as the shade. Back of rail is white to outside. End caps on fabric wrapped head, middle and bottom rails are color coordinated
Designer Metallic Upgrade	<ul style="list-style-type: none"> • Smooth faced Oil Rubbed Bronze head, middle, bottom rails and end caps • Smooth faced Brushed Nickel head, middle, bottom rails and end caps
Mounting Dimensions	
	Rechargeable Simplicity Motorization Hardware System
Minimum Shallow Mount	1/2"
Minimum Flush Inside Mount	2 1/4"
Minimum Outside Mount	7/8"
Minimum Side Mount	1 1/4"
Minimum Flush Side Mount	2 1/4"
Recommended Side Mounting Method	<ul style="list-style-type: none"> • See page 49 for recommended mounting method for side mount shades • Width limit for side mount brackets is 48"
Finished Dimensions	
Inside Mount	
	<ul style="list-style-type: none"> • Fabric will measure ordered width less: 3/8" • Head rail* will measure ordered width less: 3/16"
Outside Mount	
	<ul style="list-style-type: none"> • Fabric will measure ordered width • Head rail* will measure ordered width plus: 3/16"
Side Mount	
	<ul style="list-style-type: none"> • Fabric will measure ordered width less: 7/8" • Head rail* will measure ordered width less: 1 1/16"
Exact (End Cap to End Cap) Mount	
	<ul style="list-style-type: none"> • Fabric will measure ordered width less: 3/16" • Head rail* will measure ordered width
* Head rail measurements include endcaps. Width and length measurements may vary +/- 1/8"	

Cellular Shade Collection

RECHARGEABLE SIMPLICITY MOTORIZED HARDWARE SYSTEM

Rechargeable Simplicity Motors

The Simplicity Motor program features a battery powered motor utilizing a rechargeable battery hidden inside the shade head rail. Simplicity motors are compact and use a radio frequency remote to raise or lower the shades.

Rechargeable Motorized Lift Systems are not offered on sizes within the shaded area on the Standard Rectangular price grids.

Applications

- Standard Rectangular
- Top Down-Bottom Up see page 57

EZ Level

Learn about the EZ Level feature on page 116.

Rechargeable Simplicity Motorization Surcharges

The Rechargeable Simplicity Motorized Lift System surcharge includes a rechargeable battery. Remotes are needed to operate the shades. Refer to pricing pages.

Important Simplicity Motorized Shade Operating and Installation Information

- Simplicity Motorized Shades installed into windows with metal casings may have a reduced radio frequency range, or may not operate at all, depending on the application.
- Do not let the antenna on the motor touch any metal objects. This may interfere with signals from the remote control.

Solar Panel Recharge Option

Plugs in to any Simplicity Rechargeable Remote control shade (does not work with PowerTouch)

Provides constant trickle charge to 7.4v Li-Ion Rechargeable battery packs. Does not require direct sunlight, but performs best in regular direct sunlight applications. Will prolong the life of the charge of the 7.4v rechargeable battery packs, and in some applications will maintain charge indefinitely.

Life of charge is subject to application variables such as, size and weight of shade, frequency of use, amount of direct sunlight exposure, etc.



Dimensions of panel
18 1/2" x 1 1/2"

Simplicity Rechargeable Battery

The rechargeable battery is concealed in the head rail of the shade. A charger is required for the rechargeable battery. The rechargeable battery comes fully charged from the factory.

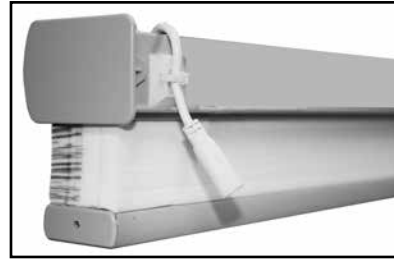

Charging Port on Back of Head rail.

Retrofit Existing Standard Simplicity Motorized Shades with Rechargeable Batteries

Cellular shades made with Standard Simplicity Motorization can be retrofitted with the Rechargeable Simplicity Motorization Battery Wand. The Rechargeable battery wand is 22" long, comes with 10 NiMH batteries, and is white in color. Battery wands are charged at the factory.

To retrofit the rechargeable battery wand to an existing shade with a cassette head rail, you must have at least 24" between bracket centerlines to fit the battery wand. Otherwise, the wand must be placed elsewhere along the window. Wall mounting clips are provided with the wand.

Retrofit Ordering Requirements:

- Rechargeable battery wand with clips (one per shade)
- Rechargeable battery charger (one or more per order, or as needed)
- Charge port mounting base (optional)

Please contact customer service for more information. Does not work with solar panel.



Battery Wand for
Rechargeable Simplicity Retrofit

RECHARGEABLE SIMPLICITY PRICING EXAMPLE:

Linen Weave	
Light Filtering 42" x 60" Shade:	\$383.00
Simplicity Rechargeable Surcharge:	\$368.00
Charger for Rechargeable :	\$30.00
Simplicity Remote Control:	\$44.00
Total List Price:	\$825.00

CELLULAR HARDWARE

Cellular Shade Collection

RECHARGEABLE SIMPLICITY MOTORIZED HARDWARE SYSTEM

Simplicity Rechargeable Battery Life

Rechargeable batteries are included with the motor.

The average battery charge will last 6-12 months based on an average sized shade raised and lowered once per day. The life of the battery charge will vary based on the type of window covering selected, the size and weight of the window covering and the number of times the shade is operated on a daily basis.

The battery can be recharged up to 500 times. It takes approximately 5 hours to recharge the motor when fully depleted.

Ordering Information for Rechargeable Motorized Cellular Shades

Simplicity Motor Option

- Specify IB or OB mount and rail color.
- Specify remote and other accessories if needed.
- Specify one or more battery chargers.

Please Note:

- Not all motors run at the same rate of speed.
- Simplicity motors have a "Favorites" position setting. If the homeowner wants to set several shades at the same intermediate position, follow instructions provided with installation manual.
- Simplicity Rechargeable Motorized Cellular Shades are programmed at the factory with the "up and down" limits. The shades are **UNLINKED** from the remote so they are not able to operate during shipping. Each shade should be installed **after** linking it to the remote.
- The Simplicity remotes utilize one 3V battery. Batteries are included. Comfortex will warranty batteries for up to 3 months from date of purchase. Remote batteries are not covered by the warranty.
- **REMEMBER: Order at least one charger if ordering rechargeable motors.**

Simplicity Motorized Shade Warranty

Please see page 122 for complete Comfortex warranty information.

Battery Charger

8.4 Volt charger requires a standard power outlet to recharge the battery wand. Must specify charger when ordering a Simplicity Rechargeable Wand Shade. The charger plugs into the charger port. The charger is black and comes with a 156" wire. The dimensions are 1" wide x 2½" length x 1¾" deep.



5 Channel Remote Control

The **5 Channel (5C) remote** can operate up to five shades individually or 5 groups. Simplicity Rechargeable Motorized Cellular Shades are programmed at the factory with the "up and down" limits. The shades are **UNLINKED** from the remote so they are not able to operate during shipping. Each shade should be installed **after** linking it to the remote.

Simplicity 5C remotes and holders are white or black in color. The remote comes with a holder which can be mounted to a wall for easy storage. The range of the remote is approximately 80 feet.



6 Channel Timer Remote Control

The **6 Channel (6C) timer remote** combines the functionality of a six channel hand-held control with the convenience of a programmable timer.

- The 6C timer remote allows for 18 different scheduled actions.
- Manual function disables the timer so then the remote operates as a held remote.

Simplicity 6C remotes and holders are white in color. The remote comes with a holder which can be mounted to a wall for easy storage. The range of the remote is approximately 80 feet.



Simplicity Rechargeable Motorized Cellular Shades are programmed at the factory with the "up and down" limits. The shades are **UNLINKED** from the remote so they are not able to operate during shipping. Each shade should be installed **after** linking it to the remote.

A **14 Channel (14C) remote** is also available. This remote is required for TDBU motorization but can be utilized on all Simplicity motorized shades. See page 58 for more information.

Simplicity Motor Hand Held Remotes Operation

Press the up or down button on the remote to raise or lower the shade to your desired position.

To reprogram channel assignments, please refer to the installation instructions and/or view the video at: comfortex.com/comfortex-dealers.

CELLULAR HARDWARE

Cellular Shade Collection

MOTORIZED TOP DOWN-BOTTOM UP HARDWARE SYSTEM

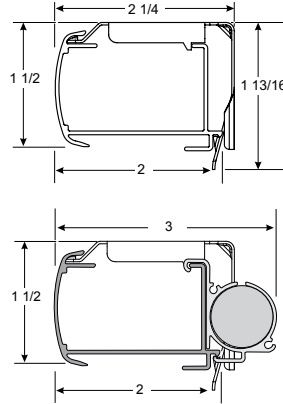

Simplicity Motorized Rail Dimensions

- Depth of rail: 2"
- Depth of rail and bracket: 2 1/4"
- Height of rail: 1 1/2"
- Height of bracket: 1 13/16"

Simplicity Motorized Rail with External Battery Dimensions (shades under 36")

- Depth of rail: 2"
- Depth of rail, bracket & battery: 3"
- Height of rail: 1 1/2"
- Height of bracket: 1 13/16"

Hardware Features	
Standard Hardware	<ul style="list-style-type: none"> • Color coordinated head, middle, and bottom rails. Head rail and Bottom rails will have frosted end caps with fabric inserts.
14 Channel TDBU Remote	Upper and lower limit stops pre-programmed
Upgrades	
Designer Metallic Upgrade	<ul style="list-style-type: none"> • Smooth faced Designer Oil Rubbed Bronze head, middle, bottom rails and end caps • Smooth faced Designer Brushed Nickel head, middle, bottom rails and end caps
Fabric Wrapped Rails	<ul style="list-style-type: none"> • Fabric used to cover the rails is the same fabric as the shade. The back of the rail will be white to the outside. End Caps will be color coordinated.

Mounting Dimensions	Simplicity Motorized Hardware System
Minimum Shallow Mount	1/2"
Minimum Flush Inside Mount	2 1/4"
Minimum Outside Mount	7/8"
Minimum Side Mount	1 1/4"
Recommended Side Mounting Method	<ul style="list-style-type: none"> • See page 68 for recommended mounting method for side mount shades • Width limit for side mount brackets is 48"

Finished Dimensions	
Inside Mount	
	<ul style="list-style-type: none"> • Fabric will measure ordered width less: 3/8" • Head rail* will measure ordered width less: 3/16"
Outside Mount	
	<ul style="list-style-type: none"> • Fabric will measure ordered width • Head rail* will measure ordered width plus: 3/16"
Side Mount	
	<ul style="list-style-type: none"> • Fabric will measure ordered width less: 7/8" • Head rail* will measure ordered width less: 1 1/16"
Exact (End Cap to End Cap) Mount	
	<ul style="list-style-type: none"> • Fabric will measure ordered width less: 3/16" • Head rail* will measure ordered width

* Head rail measurements include endcaps. Width and length measurements may vary +/- 1/8"

Cellular Shade Collection

MOTORIZED TOP DOWN-BOTTOM UP HARDWARE SYSTEM

Rechargeable Simplicity Motors

The Simplicity TDBU Motor program features a battery powered motor utilizing a rechargeable battery hidden inside the shade head rail. If shades are less than 36" in width, an external snap-on battery pack is necessary.

(See picture to right)

Applications

- TDBU Rectangular

EZ Level

Learn about the EZ Level feature on page 116.

Rechargeable Simplicity Motorization Surcharges

The Rechargeable Simplicity Motorized Lift System surcharge includes a rechargeable battery. Remotes are needed to operate the shades. Refer to pricing pages.

Ordering Information for Top Down-Bottom Up Motorized Cellular Shades

Simplicity Motor Option

- Specify IB or OB mount and rail color.
- 14 Channel TDBU Remote is required.
- Specify one or more battery chargers.

Please Note:

- Shades that are 24"-36" in width will have an external battery.
- Shades with an external battery and OB mounted will need spacer blocks.
- Simplicity Rechargeable Motorized Cellular Shades are programmed at the factory with the "up and down" limits.
- **REMEMBER: Order at least one charger if ordering rechargeable motors.**

Top Down-Bottom Up Simplicity Motor Hand Held 14 Channel Remote

The TDBU remote has 14-channels. Each channel has a setting able to operate the middle rail and a setting able to operate the bottom rail. The TDBU remote is required for TDBU motors, but can be used with other motors as well. The **14 Channel TDBU remote** can operate up to fourteen shades individually or 14 groups. Simplicity Rechargeable Motorized Cellular Shades are programmed at the factory with the "up and down" limits. The shades are **UNLINKED** from the remote so they are not able to operate during shipping. Each shade should be installed **after** linking it to the remote.

Simplicity TDBU remotes and holders are white in color. The remote comes with a holder which can be mounted to a wall for easy storage. The range of the remote is approximately 80 feet. A **14 Channel (14C) remote** can be utilized on all Simplicity motorized shades.



Simplicity Rechargeable Battery for TDBU

The rechargeable battery is concealed in the head rail of the shade. A charger is required for the rechargeable battery. The rechargeable battery comes fully charged from the factory.

Rechargeable Battery Pack is concealed in the head rail. Minimum width of 36" is required otherwise battery wand must be mounted externally.

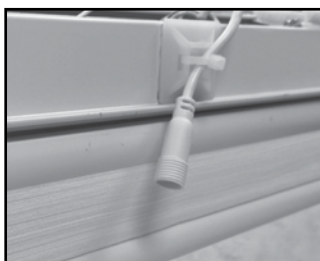

Charging Port on Back of Head rail.

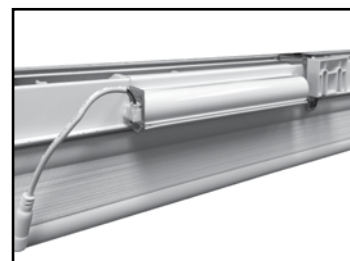

Snap-On external battery for TDBU shades under 36" in width. Spacer block also required for outside mount.

Battery Charger

8.4 Volt charger requires a standard power outlet to recharge the battery wand. Must specify charger when ordering a Simplicity Rechargeable Wand Shade. The charger plugs into the charger port. The charger is black and comes with a 156" wire. The dimensions are 1" wide x 2 1/2" length x 1 3/4" deep.

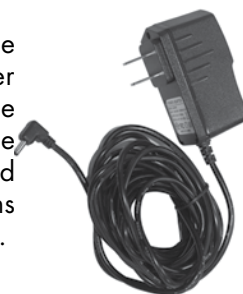

Solar Panel Recharge Option

Plugs in to any Simplicity Rechargeable Remote control shade (does not work with PowerTouch). See page 78.



Dimensions of panel 18 1/2" x 1 1/2"

MOTORIZED TOP DOWN-BOTTOM UP PRICING EXAMPLE:

Linen Weave	
Light Filtering 42" x 60" Shade:	\$383.00
Simplicity Rechargeable	
TDBU Surcharge:	\$589.00
Charger for Rechargeable:	\$30.00
TDBU Remote Control:	\$72.00
Total List Price:	\$1074.00

CELLULAR HARDWARE

Cellular Shade Collection
SIMPLICITY SMART CONTROLLER

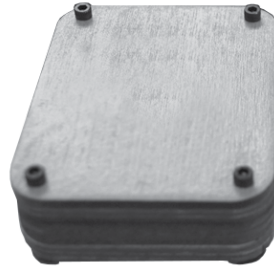

Simplicity Smart Controller Dimensions

- Width of controller: 2³/₈"
- Length of controller: 2¹⁵/₁₆"
- Height of controller: 1¹/₈"

Simplicity Smart Controller	
	<ul style="list-style-type: none"> • Works with Apple and Android devices • FREE Downloadable Application • Compatible with previously installed Simplicity Remote Control Shades • Powered by NEO Smart Blinds App • Compatible with Amazon Alexa and Google Assistant systems

Simplicity Smart Controller

The Simplicity Smart Controller is a small device that you install in your home that allows you to set automatic opening and closing times for all Simplicity motorized shades as well as the ability to control your motorized shades from a phone, tablet or PC from anywhere in world.

The Simplicity Smart Controller will work with any Comfortex remote motorized shade with Simplicity remote control motors purchased after 2012.

The Simplicity Smart Controller plugs into a standard electrical outlet and connects to WiFi and sends signals to your shades using the same radio frequencies as a normal remote control.

How Does The NEO Smart Blinds App Work?

The app uses WiFi or cellular data to send commands over the internet to the Simplicity Smart Controller.

Do I Need Any Other Equipment?

Yes, The location where your shades are installed must have WiFi in order for the Simplicity Smart Controller to work. Additionally, you must have a smartphone or tablet running Android or iOS (eg. iPhone, iPad, Samsung Galaxy S7) and have the NEO Smart Blinds app. installed.

Why Would I Want A Simplicity Smart Controller?

There are two main ways the Simplicity Smart Controller adds additional value to your motorized shades. First, once all of your shades have been added, you can use your smartphone as a single remote for all of your shades that will work anywhere you are regardless of distance from the shade. Secondly, the device allows you to set schedules so your motorized shades automatically open and close without needing to do anything on a day to day basis.

Do I Need To Buy More Than 1 Controller?

The normal use for the Simplicity Smart Controller is to plug it in out of the way and forget it. Since it has roughly the same range as a remote you will want enough devices to allow all shades to be operated without moving the controller. So depending on the layout of the home and location of the shade, you might want multiple devices to have convenient full home coverage.

How Far Is The Range Of A Controller?

You should see a range of approximately 150 ft. However this number might be less depending on the layout of your home. In general we recommend one per a floor of a normal sized home.

Can I Control My Shades From Multiple Devices?

Yes! You can download the NEO Smart Blinds App. onto multiple devices, After installing the App. on a new device simply log in with the same email/password on each device and you will have access to control your shades.

Can It Be Used With Already Installed Shades?

Yes! Simply follow the directions in the NEO Smart Blinds app. to add a shade. At the pairing step you can put the shade in pairing mode using the primary remote control for it (or by accessing the button on the shades motor). Adding the shade to the NEO Smart Blinds App. will not affect the normal remote operation.

How Much Does The NEO Smart Blinds App Cost?

The app is a free download, However you must have at least one Simplicity Smart Controller to serve as a bridge between the app and your shades. See page 10.

Cellular Shade Collection

POWERTOUCH RECHARGEABLE MOTORIZED HARDWARE SYSTEM

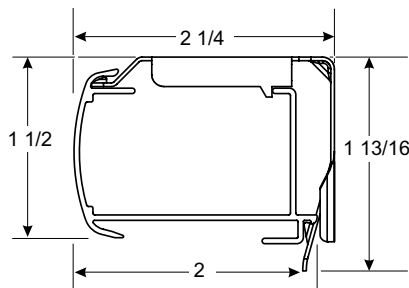
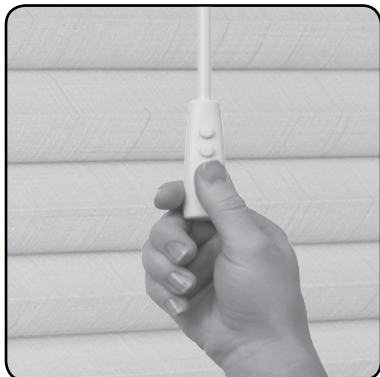

Simplicity Motorized Rail Dimensions

- Depth of rail: 2"
- Depth of rail and bracket: 2 1/4"
- Height of rail: 1 1/2"
- Height of bracket: 1 13/16"

CELLULAR HARDWARE

Hardware Features	
Hardware colors for all Cellular and Pleated fabrics	Color coordinated head, bottom rails and end caps
Standard Hardware for all Custom Graphics	White head and bottom rails and end caps
Simplicity Remote	Upper and lower limit stops pre-programmed, Intermediate stop "favorites" position can be set on site
Upgrades	
Fabric Wrapped Upgrade	Fabric used is same fabric as the shade. Back of rail is white to outside. End caps on fabric wrapped head, middle and bottom rails are color coordinated
Designer Metallic Upgrade	<ul style="list-style-type: none"> • Smooth faced Oil Rubbed Bronze head, bottom rails and end caps • Smooth faced Brushed Nickel head, bottom rails and end caps

Mounting Dimensions	Simplicity Motorized Hardware System
Minimum Shallow Mount	1/2"
Minimum Flush Inside Mount	2 1/4"
Minimum Outside Mount	7/8"
Minimum Side Mount	1 1/4"
Minimum Flush Side Mount	2 1/4"
Recommended Side Mounting Method	<ul style="list-style-type: none"> • See page 68 for recommended mounting method for side mount shades • Width limit for side mount brackets is 48"

Finished Dimensions	
Inside Mount	
	<ul style="list-style-type: none"> • Fabric will measure ordered width less: 3/8" • Head rail* will measure ordered width less: 3/16"
Outside Mount	
	<ul style="list-style-type: none"> • Fabric will measure ordered width • Head rail* will measure ordered width plus: 3/16"
Side Mount	
	<ul style="list-style-type: none"> • Fabric will measure ordered width less: 7/8" • Head rail* will measure ordered width less: 1 1/16"
Exact (End Cap to End Cap) Mount	
	<ul style="list-style-type: none"> • Fabric will measure ordered width less: 3/16" • Head rail* will measure ordered width

* Head rail measurements include endcaps. Width and length measurements may vary +/- 1/8"

Cellular Shade Collection

POWERTOUCHE RECHARGEABLE MOTORIZED HARDWARE SYSTEM

PowerTouch™ Rechargeable Shades

Cellular Shades can be fabricated with the PowerTouch Rechargeable Push Button Control option. The PowerTouch Rechargeable option is an easy, cord free motorized operation for the budget savvy homeowner. PowerTouch Rechargeable uses Simplicity motors and components.

PowerTouch Rechargeable Shades Operation

Press the up or down button on the pendant to raise or lower the shading to your desired position.

No programming is required with PowerTouch™, all programming is set at the factory. Upper and lower limits can easily be adjusted in the field if desired. Please refer to the installation instructions at comfortex.com/comfortex-dealers. A "favorites" or intermediate stop position can be set once installed.

PowerTouch Rechargeable Surcharges

See page 10.

PowerTouch Appearance

- The PowerTouch wand and pendant is attached to the head rail when installed.
- The wand and pendant hangs down the front of the shades from the head rail. The wand does not touch the fabric.
- Pendant is 2½" long.
- The pendant does not need to be mounted to the wall to operate the shade.



PowerTouch Rechargeable Color Options

- Shades with Black or Oil Rubbed Bronze hardware will be built with black wand and pendants standard. All other colors will use white wand and pendants.



White



Black Shown with Plug-In Charger

PowerTouch Wand and Pendant Location

The standard location for the wand and pendant is on the right. Please specify location when ordering.

PowerTouch Rechargeable Wand Length

- The standard length of the wand will measure the indicated below unless otherwise specified.

Shading Length	Standard Wand Length
Up to 30"	1' (12")
>30" to 52"	2' (24")
>52" to 78"	3' (36")
>78" to 100"	4' (48")
>100" to 120"	5' (60")

Mounting Requirements for PowerTouch Rechargeable Shades

- No special installation hardware or wiring requirements are needed.

Battery Charger

8.4 Volt charger requires a standard power outlet to recharge the battery wand. Must specify charger when ordering a Simplicity Rechargeable Wand Shade. The charger plugs into the charger port. The charger is black and comes with a 156" wire. The dimensions are 1" wide x 2½" length x 1¾" deep.



PowerTouch Rechargeable Shades Warranty

Please see page 122 for complete warranty information.

Cellular Shade Collection

OVATION CELLULAR SLIDER HARDWARE SYSTEM

Prelude Hardware Page 98

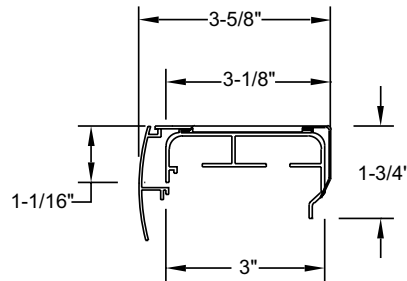

Ovation Hardware Rail Dimensions

- Depth of rail: 3"
- Depth of rail and bracket: 3 1/8"
- Depth of rail, bracket & valance: 3 5/8"
- Height: 1 3/4"

CELLULAR HARDWARE

Hardware Features	
Standard Hardware Color	Aspen White #785
Optional Hardware Colors	Ivory, beige, tan and gray rails are available as an option. Visit comfortex.com to view color options <ul style="list-style-type: none"> • Silverado #276 • Honey Bisque #882 • Camel #082 • Gardenia White #862

Mounting Dimensions	Ovation Hardware System
Minimum Inside Mount	3/4"
Minimum Flush Mount	3 5/8"
Minimum Outside Mount	5/8"

Finished Dimensions

Inside Flush Mount	
Track Width:	
Right or Left Stack	3/16" less than ordered width
Split Stack	3/16" less than ordered width
Center Stack	3/16" less than ordered width
Finished Slider Length	1/2" less than ordered length
Valance	3/16" less than ordered width

Outside Mount	
Track Width	Ordered width
Finished Slider Length	Ordered length - No reductions will be made
Valance	Ordered width plus 1 1/4"
Valance Returns	Will measure 3 1/8" (standard)

Cellular Shade Collection

OVATION CELLULAR SLIDER HARDWARE SYSTEM

Prelude Hardware Page 98

Applications

- Standard Rectangular
- Opens and closes from side to side
- Four stacking options - see below.
- Dual Panel option with a center opening design with two fabrics, one on each side, each spanning the width of the window.

Ovation Stacking Options

Specify stacking configuration when ordering.

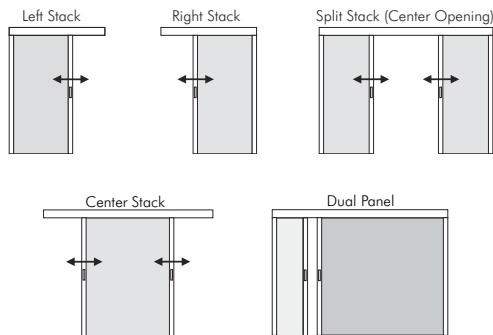

Left: Fabric stacks to the left side of the slider.

Right: Fabric stacks to the right side of the slider.

Center Stack: Center Stack Sliders fabric panels can move fully to the left or the right.

Split Stack: Fabric is split in the center of the slider forming two equal panels which open to opposite ends of the slider. Both panels will be of equal width unless otherwise specified. Split stack is not available with Gradient shades.

* Split stack sliders are available in maximum widths from 240" to 336" (maximum width depends on the fabric selected). If the width exceeds the maximum width of the fabric, it will be fabricated as two separate sliders. The supplied valance will create the appearance of a single slider. Call Customer Service for assistance.

Dual Panel: A Dual Panel Stack Slider has a center opening design with a different fabric on each side, each of which can span the full width of the window. Both panels will be of equal width unless otherwise specified. Specify which fabric stacks to left and which fabric stacks to the right.

Ordering Information for Ovation Cellular Sliders

- Specify IB or OB mount.
- Specify stacking configuration.
On Dual Panel Shades, specify which fabric stacks to the left and right.
On Split Stack Shades, both panels will be of equal width unless specified.
- Specify valance width and return length.

Ovation Valance Specifications

- Every Ovation Slider is supplied with a painted aluminum valance to match your hardware color choice.
- The valance attaches to the head rail using a durable plastic clip system.

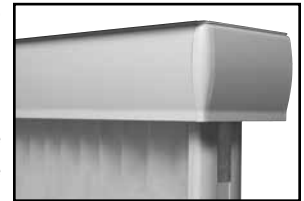

Ovation Valance Dimensions

All valance dimensions are measured on the flat, back side.

- Valance Height: 2¾"
- Standard Return Length (OB only): 3⅛"
- For each spacer block, ½" will be added to the length of the valance returns. For extension brackets, 2" will be added unless otherwise instructed.
- If the slider requires a non-flush inside mount, you must order a custom valance. Exact valance width and exact valance return length (minimum 1½") must be specified in the Special Instructions section of the order form.
- Custom returns are available for IB non-flush and OB Cellular Sliders. Please specify return length upon ordering.

Things to Consider

- Since most Ovations are sold in large sizes, the shade will have a large fabric stack. On an outside mount, you may want to order the shade a few inches wider so that the fabric stack can be clear of the window. For more information on Ovation's stack height, see pages 8-9 for information.
- Premiere Custom Design fabrics will be turned 90 degrees on Ovation Shades. The pattern orientation will be left to right since Ovation shades open side to side. Split stack is not available with Gradient shades.
- Symphony double honeycomb fabric may require additional care when opening or closing the shade. Double honeycomb fabric is generally stiffer than single honeycomb material and may offer minor resistance when opening and closing. If this is a concern, Comfortex recommends selecting a coordinating fabric from the Virtuoso or Baritone collections.

CELLULAR HARDWARE

The Ultimate Blackout Cellular Shade

INSULATING SLUMBERSHADES HARDWARE SYSTEM



Standard Head Rail

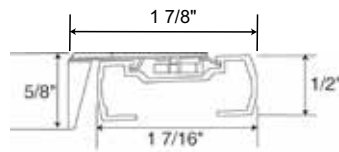

Deluxe Head Rail

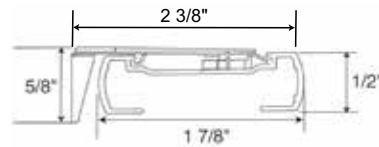

Cord Loop & Cordless Ultra Head Rail (Standard & Top Down-Bottom Up)

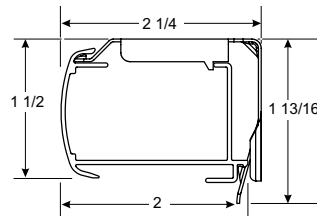

Standard Cord Lock Rail

- Depth of rail: 1 7/16"
- Depth of rail and bracket: 1 7/8"
- Height of rail: 1/2"
- Height of bracket: 5/8"

Deluxe Cord Lock Rail

- Depth of rail: 1 7/8"
- Depth of rail and bracket: 2 3/8"
- Height: 1/2"
- Height of bracket: 5/8"

Cord Loop & Cordless Ultra Rail

- Depth of rail: 2"
- Depth of rail and bracket: 2 1/4"
- Height of rail: 1 1/2"
- Height of bracket: 1 13/16"

CELLULAR HARDWARE

Hardware Features		
Hardware colors for all Cellular fabrics	Color coordinated head, middle, bottom rails and end caps	
Blackout Sidetrack Colors Available	White, Tan and Bronze	
Upgrades		
Fabric Wrapped Upgrade	Fabric used is same fabric as the shade. Back of rail is white to outside.	
Designer Metallic Upgrade	• Oil Rubbed Bronze and Brushed Nickel head, middle, bottom rails and end caps.	
Mounting Dimensions (inside mount only)	Standard Head Rail	Deluxe Head Rail
Standard Cord Lock (Standard Rectangular and Top Down-Bottom Up)		
Minimum Inside Mount	1 1/2"	1 1/2"
Minimum Flush Inside Mount	2"	2 3/8"
Cord Loop & Cordless Ultra (Standard Rectangular and Top Down-Bottom Up)		
Minimum Inside Mount	1 5/8"	NA
Minimum Flush Inside Mount	2 1/4"	NA
Outside, shallow and side mounts are not available. The shade's light blocking ability is compromised by using any other mount than a fully flush mount application.		
Finished Dimensions		
Inside Mount		
	<ul style="list-style-type: none"> • Fabric will measure ordered width less: 7/8" • Head rail and bottom rail will measure ordered width less: 1 1/16" • Sidetrack length will measure ordered length less: 1/8" 	

The widest width of the window cannot exceed the narrowest width of the window by more than 1/4".

Precise width measurements are critical to proper performance of SlumberShade products. Make sure to measure to the nearest 1/16" and provide the **NARROWEST** width measurement along the length of the window. Be sure to measure the top, middle and bottom of the opening. It is very common for the width of a window to vary from top to bottom.

The Ultimate Blackout Cellular Shade

INSULATING SLUMBERSHADES HARDWARE SYSTEM

Insulating SlumberShades Small Track Dimensions

Used with all fabrics standard size head rail.

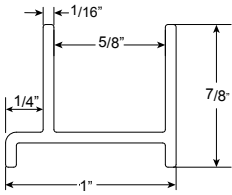

Small Track

- Width of track: 1"
- Height of track: 7/8"

Insulating SlumberShades Large Track Dimensions

Used with all fabrics that utilize the deluxe sized head rail.

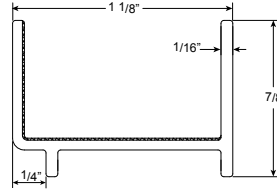

Large Track

- Width of track: 1 1/8"
- Height of track: 7/8"

Applications

- Standard Rectangular
- Top Down - Bottom Up
- Cordless and Cordless Top Down - Bottom Up
- Cord Loop and Top Down - Bottom Up
- Motorization

SlumberShades are for inside mount applications only.

Insulating SlumberShade Fabric

Light Filtering fabrics are available as SlumberShades, however the best light control is achieved by using a blackout cellular fabric.

Ordering Information for Insulating SlumberShades

SlumberShades are for inside mount applications only.

Precise width measurements are critical to proper performance of SlumberShade products. Make sure to measure to the nearest 1/16" and provide the **NARROWEST** width measurement along the length of the window. Be sure to measure the top, middle and bottom of the opening. It is very common for the width of a window to vary from top to bottom. The widest width of the window cannot exceed the narrowest width of the window by more than 1/4".

If you have questions about ordering SlumberShades, contact Comfortex Technical Services at 800-843-4151.

Accessories

- 6' Expandable
- 12' Expandable

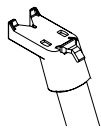

Specially designed pole end fits into the handle on the Cordless Ultra bottom rail and allows for easy operation.

Insulating SlumberShades Features

Use SlumberShades to provide the darkest sleeping environment by sealing out all the light

Energy Saving Blackout Sidetracks

Energy saving blackout sidetracks are made from a durable window grade PVC. The blackout sidetracks seal off the light gap between the blackout cellular shade and the window. The blackout sidetracks feature a black interior lining to absorb light and prevent it from entering the room.



SlumberShades are easy to install, and feature removable sidetracks that are attached to the window frame with magnets. The sidetracks can be removed for window cleaning. The UV stable, window grade PVC sidetracks are available in white, tan and bronze to match your existing trim.

Please Note: When properly installed, SlumberShades block 99% of all visible light. In certain installations with intense sunlight, a very small amount of light may reflect around the edges of the honeycomb fabric along each side of the shade. This is a normal attribute of the SlumberShade system.

Insulating SlumberShade End Caps

The specially designed notched bottom rail end caps fit over the blackout sidetracks and allow for smooth movement when raising and lowering the shade.

Head and Bottom Rail Seals

To ensure a perfectly dark sleeping environment, additional fuzz seals are supplied to be placed along the shade's bottom rail and between the head rail and the window frame if needed. These barriers provide a complete light stop all the way around the window to keep all exterior light out. Also, these additional seals provide a very effective barrier against heat loss along your windows.

Magnets and fuzz bar are standard on Cordless and Cordless Top Down-Bottom Up Shades to ensure closure between the bottom rail and window sill.

Energy Efficiency

Independent testing has shown SlumberShades provide an R-value greater than 7.0* when installed over a double paned vinyl window. The testing also indicates that the R-value of a SlumberShade is 2.5 to 3 times higher than that of the same shade without sidetracks. The insulating cellular fabric, sidetracks, and fuzzy seal all ensure that the SlumberShades provides superior energy efficiency.

* Independent testing provided by Consortium for Advanced Residential Buildings (CARB), a U.S. Department of Energy Building America research team. Learn more at comfortex.com/comfortex-dealers.

EZ Level

Learn about the EZ Level feature on page 116.

Cellular Specialty Shades

STARBURST ARCHES HARDWARE SYSTEM

Prelude Hardware Page 107

Stationary Starburst

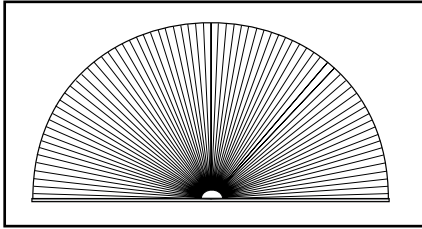

Figure A

Movable Starburst

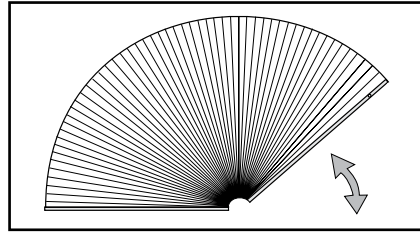

Figure B

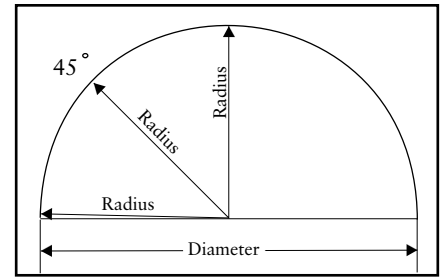

Figure C

Hardware Features See Page 46 for Rail Dimensions		
Hardware colors	Color coordinated rails	
Upgrades		
Fabric Wrapped Upgrade	Fabric used is same fabric as the shade. Back of rail is white to outside. Color coordinated end caps. Please note: On Stationary Starburst Arches the fabric wrap will be spliced in the center of the base rail.	
Designer Metallic Upgrade	<ul style="list-style-type: none"> Oil Rubbed Bronze rails with bronze colored end caps. Brushed Nickel rails and end caps. 	
Mounting Dimensions		
Mounting Dimensions	Standard Cord Lock Rail	Deluxe Cord Lock Rail
Minimum Shallow Mount	3/4"	3/4"
Minimum Flush Inside Mount	2"	2 3/8"
Recommended Side Mounting Method	<ul style="list-style-type: none"> See page 47 figure B for recommended mounting method for side mount shades Width limit for side mount brackets is 48" 	
Finished Dimensions		
Inside and Side Mount		
<ul style="list-style-type: none"> Fabric will measure ordered width less: 3/8" Head rail* will measure ordered width less: 3/16" 	<ul style="list-style-type: none"> * Head rail measurements include endcaps. Width and length measurements may vary +/- 1/8" 	

Applications

- Stationary Fan Style Arch
 - Movable Fan Style Arch
- Movable Starburst Arch shades are for inside and shallow mount applications only.

Stationary Starburst Features (Figure A)

- All non-perfect Stationary Starburst arches require a template made from brown craft paper. Comfortex offers template kits. Please contact Customer Service to order. Stock number: 751000, See page 119
- A perfect arch is twice as wide as it is high.
- Stationary Starburst shades which are not perfect half circles must have a height that equals half the width +/- 5".
- Price according to the largest radius measurement. If the height is greater than the width, take height X 2 and use that number to determine pricing.
- When ordering arches as perfect half-circles make sure the radius of the arch remains constant to ensure a proper fit. (See Figure C)

Movable Starburst Features (Figure B)

- Starburst Movable archtop shades are cut to perfect half circles only and do not require a template. The height must be exactly 1/2 the diameter.
- A perfect arch is twice as wide as it is high.
- When ordering arches as perfect half circles make sure the radius of the arch remains constant to ensure a proper fit. (See Figure C)
- The hinge gap (gap between the two rails) is not centered in the window. The moving rail is always smaller than the stationary rail to provide proper movement within the window.

Accessories

- 6' Expandable Pole
- 12' Expandable Pole



Specially designed pole end fits into the handle on movable Starburst Shades for easy operation.

CELLULAR HARDWARE

Cellular Specialty Shades

SUNSET ARCHES HARDWARE SYSTEM

Prelude Hardware Page 107

Movable Sunset

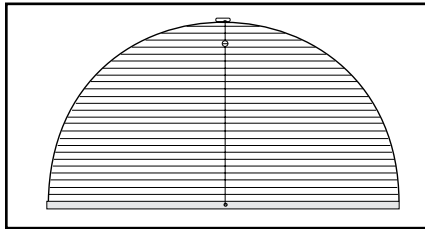

Figure A

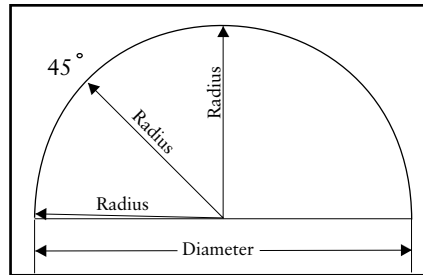

Figure B

Two-String Hanging Method

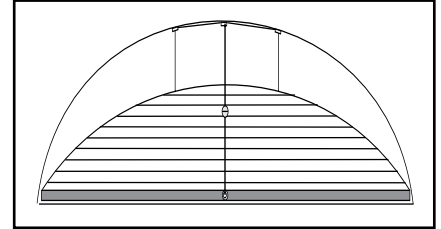

Figure C

Hardware Features See Page 46 for Rail Dimensions	
Hardware colors for all Cellular fabrics	Color coordinated rails with white cord and silver tassel
Upgrades	
Fabric Wrapped Upgrade	Fabric used is same fabric as the shade. Back of rail is white to outside. Color coordinated end caps.
Designer Metallic Upgrade	<ul style="list-style-type: none"> • Oil Rubbed Bronze rails with bronze end caps, white cord and silver tassel. • Brushed Nickel rails and end caps with silver tassel and white cord.
Mounting Dimensions	Standard Cord Lock Rail
Minimum Shallow Mount	3/4"
Minimum Flush Inside Mount	2"
Minimum Outside Mount	3/4"
Minimum Side Mount	1 1/8"
Minimum Flush Side Mount	1 5/8"
Recommended Side Mounting Method	<ul style="list-style-type: none"> • See page 47 figure B for recommended mounting method for side mount shades • Width limit for side mount brackets is 48"
Finished Dimensions	
Inside and Side Mount	
	<ul style="list-style-type: none"> • Fabric will measure ordered width less: 3/8" • Head rail* will measure ordered width less: 3/16"
Outside Mount	
	<ul style="list-style-type: none"> • Fabric will measure ordered width • Head rail* will measure ordered width plus: 3/16"
Exact (End Cap to End Cap) Mount	
	<ul style="list-style-type: none"> • Fabric will measure ordered width less: 3/16" • Head rail* will measure ordered width
* Head rail measurements include endcaps. Width and length measurements may vary +/- 1/8"	

CELLULAR HARDWARE

Applications

- Movable Arch

Ordering Information for Sunset Shades

- Specify IB or OB mount and rail color.
- Include a template if the shade is wider than 58".

Accessories

- 6' Expandable Pole
- 12' Expandable Pole



Specially designed pole end fits into the ball on Sunset Shades for easy operation.

Cellular Specialty Shades

SUNSET ARCHES HARDWARE SYSTEM

Prelude Hardware Page 101

Sunset Features and Ordering Notes (Figure A)

- Sunset shades have horizontal pleats that stack at the bottom, on a stationary sill rail. Sunset shades are operated by a continuous cord that runs through a top mount guide block and back down through the stationary rail. A moving metal ball attached to the cord is used to raise and lower the shade. (See Figure E).
- **All Sunset arches which are not perfect half circles require a template if shade is wider than 58".** A perfect arch is twice as wide as it is high. See page 119 for template instructions.
- **All templates should be made from brown craft paper.** Comfortex offers template kits. Please contact Customer Service to order. Stock number: 751000
- Sunset shades which are not perfect half circles must have a height which is equal to or greater than 25% of the width.
- When ordering Sunset shades that are perfect half circles, make sure the radius of the arch remains constant to ensure a proper fit. (See Figure B) on page 67.
- **Size Limitations:** Though our maximum width is 84" and our maximum length is 72", there are limitations on some larger sizes due to excessive weight. If the Sunset width exceeds 66", the maximum length is 60". If the Sunset width exceeds 72", the maximum length is 48".
- **Stringing Method:** Depending on the curvature of a particular arch, it may be necessary to use the two string method to ensure proper fit and operation of your Sunset shade. Comfortex will determine the best stringing method after examination of the template.
- **For Symphony (All), Premiere 1/2" Fabrics, and Debut 1/2" single:** If Sunset shades exceed 65" in width or 50" in length, two pieces of mono filament cord are included to help stabilize the shade once installed.
- **For Debut 1/2" double, Debut 3/4" Fabrics and Linen Weave fabrics:** If Sunset shades exceed 45" in width or in length, two pieces of mono filament cord are included to help stabilize the shade once installed.
- **Arch Styles:** Sunset arches are available in a variety of styles including: palladium, eyebrow and bullet shaped arches. (See Figure D).

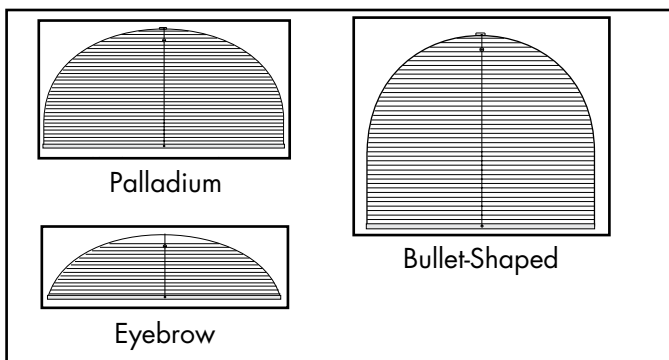

Figure D

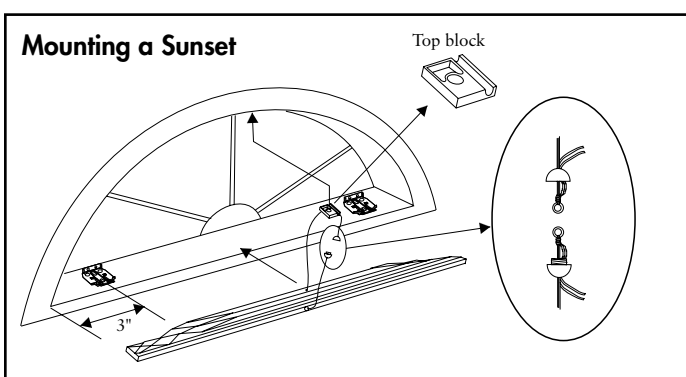

Figure E

Recommended Mounting Method for Side Mounting Shades

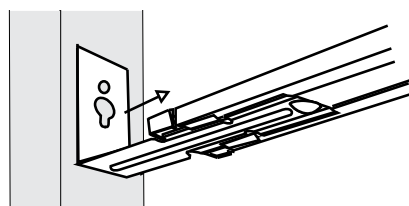

Figure F

Refer to the installation instructions on Comfortex.com/comfortex-dealers or the OnDemand Mobile Library for further details on side mounting shades.

CELLULAR HARDWARE

Cellular Specialty Shades

QUARTER ROUNDS HARDWARE SYSTEM

Prelude Hardware Page 103

Movable Quarter Round

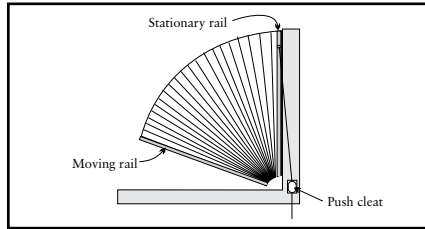

Figure A

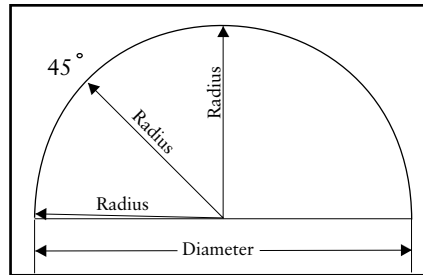

Figure B

Stationary Quarter Round

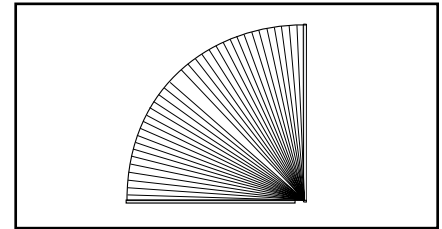

Figure C

Hardware Features See Page 46 for Rail Dimensions	
Hardware colors for all Cellular fabrics	Color coordinated rails with white cord and tassel
Upgrades	
Fabric Wrapped Upgrade	Fabric used is same fabric as the shade. Back of rail is white to outside. Color coordinated end caps.
Designer Metallic Upgrade	<ul style="list-style-type: none"> • Oil Rubbed Bronze rails and endcaps, bronze colored tassel and white cord. • Brushed Nickel rails and end caps with coordinating tassel and white cord.
Mounting Dimensions	
Standard Rail	Deluxe Rail
Minimum Shallow Mount	3/4"
Minimum Flush Inside Mount	2"
Minimum Outside Mount	3/4"
Minimum Side Mount	1 1/8"
Minimum Flush Side Mount	1 5/8"
Recommended Side Mounting Method	<ul style="list-style-type: none"> • See page 68 figure F for recommended mounting method for side mount shades
Finished Dimensions	
Inside and Side Mount	
	<ul style="list-style-type: none"> • Fabric will measure ordered width less: 3/8" • Head rail* will measure ordered width less: 3/16"
Outside Mount	
	<ul style="list-style-type: none"> • Fabric will measure ordered width • Head rail* will measure ordered width plus: 3/16"
Exact (End Cap to End Cap) Mount	
	<ul style="list-style-type: none"> • Fabric will measure ordered width less: 3/16" • Head rail* will measure ordered width
* Head rail measurements include endcaps. Width and length measurements may vary +/- 1/8"	

CELLULAR HARDWARE

Applications

- Stationary Fan Style Quarter Round
- Movable Fan Style Quarter Round

Accessories

- 6' Expandable Pole
- 12' Expandable Pole



Ordering Information for Quarter Rounds Shades

- Specify IB or OB mount and rail color.
- Include a template if the shade is a non-perfect quarter round.

Specially designed pole end fits into the handle on movable Quarter Round Shades for easy operation.

Cellular Specialty Shades

QUARTER ROUNDS HARDWARE SYSTEM

Prelude Hardware Page 103

Quarter Rounds Features (Figure A) pg 69

- **All Quarter Round Shades which are not perfect quarter circles require a template.** Price according to the largest radius measurement.
- See page 119 for template instructions.
- **All templates should be made from brown craft paper.** Comfortex offers template kits. Please contact Customer Service to order. Stock number: 751000
- The horizontal (moving) rail of a Movable Quarter Round shade **must be smaller** than the vertical (stationary) rail to allow clearance for the moving rail. The shade will stack in the vertical position.
- When ordering arches as perfect quarter circles, make sure the radius of the arch remains constant to ensure a proper fit. (See Figure B) pg 69



Operation

Moveable Quarter Round

Pull the cord down to bring the shade to a stacked position.

The shade stacks against the vertical rail.

Push the button in on the cord cleat to release the cord and lower the shade across the window.

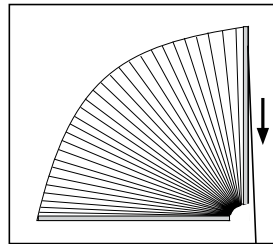

WARNING: To avoid possible strangulation, keep cords out of reach of children.

Cellular Specialty Shades

TRAPEZOIDS AND OCTAGONS HARDWARE SYSTEM

Prelude Hardware Page 104

Movable Trapezoids

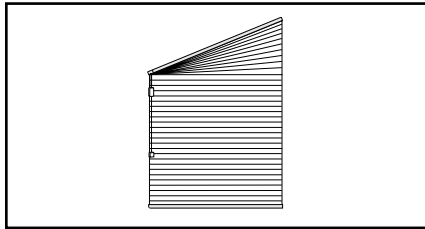

Movable Octagons

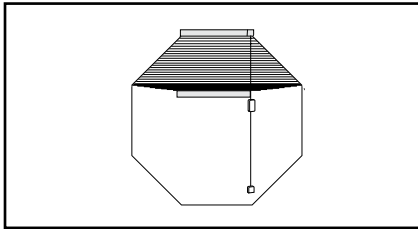

Hardware Features See Page 46 for Rail Dimensions		
Hardware colors for all Cellular fabrics	Color coordinated head and bottom rails with white cord and tassel	
Upgrades		
Fabric Wrapped Upgrade	Fabric used is same fabric as the shade. Back of rail is white to outside. Color coordinated end caps.	
Designer Metallic Upgrade	<ul style="list-style-type: none"> • Oil Rubbed Bronze head and bottom rails with bronze colored tassel, end caps and white cord. • Brushed Nickel head and bottom rails and end caps with coordinating tassel and white cord. 	
Mounting Dimensions	Standard Cord Lock Rail	Deluxe Cord Lock Rail
Minimum Shallow Mount	3/4"	3/4"
Minimum Flush Inside Mount	2"	2 3/8"
Minimum Outside Mount	3/4"	3/4"
Minimum Side Mount	1 1/8"	1 3/8"
Minimum Flush Side Mount	1 5/8"	1 7/8"
Recommended Side Mounting Method	• See page 68 for recommended mounting method for side mount shades	
Finished Dimensions		
Inside and Side Mount		
	<ul style="list-style-type: none"> • Fabric will measure ordered width less: 3/8" • Head rail* will measure ordered width less: 3/16" 	
Outside Mount		
	<ul style="list-style-type: none"> • Fabric will measure ordered width • Head rail* will measure ordered width plus: 3/16" 	
Exact (End Cap to End Cap) Mount		
	<ul style="list-style-type: none"> • Fabric will measure ordered width less: 3/16" • Head rail* will measure ordered width 	
* Head rail measurements include endcaps. Width and length measurements may vary +/- 1/8"		

Applications

- Movable Trapezoids
- Movable Octagons

Ordering Information for Trapezoid Shades

- Specify IB or OB mount and rail color.
- **Trapezoid orders must be faxed or emailed in with a diagram. Please provide measurements for all four sides when ordering. No template is required.**

Ordering Information for Octagon Shades

- Specify IB or OB mount and rail color.
- **Octagon Shades do not require a template. The width, length and one side are required measurements when ordering.**

CELLULAR HARDWARE

Cellular Specialty Shades

TRAPEZOIDS AND OCTAGONS HARDWARE SYSTEM

Prelude Hardware Page 104

Trapezoids (Figure A)

- **Trapezoid orders must be faxed in with a diagram. Please provide measurements for all four sides when ordering. No template is required.**
- The maximum slope of the top rail is 30 degrees from horizontal. Slope is the angle between slope and a horizontal line. The slope angle must be measured with a protractor.
- Sides of trapezoid must be parallel.
- Sill must be level for proper installation and operation of a trapezoid shade.
- Operating cord must be placed on the short side.
- See Figures B and C for trapezoid shade operation.

Octagons

- **Octagon Shades do not require a template.**
- **The width, length and one side are required measurements when ordering.**
- Octagon shades raise only to the point where the top angle begins. (See Figure D)
- See Figure F on page 68 for recommend mounting method for side mount shades.

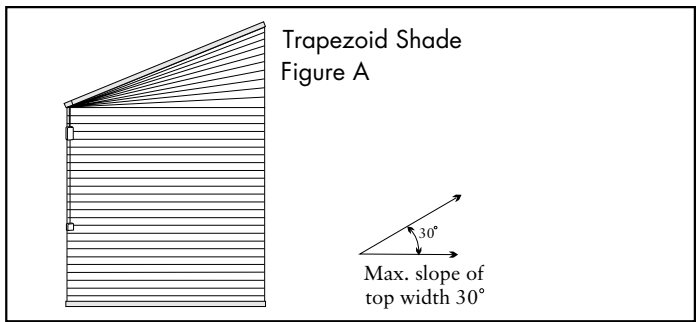

Trapezoid Shade Operation

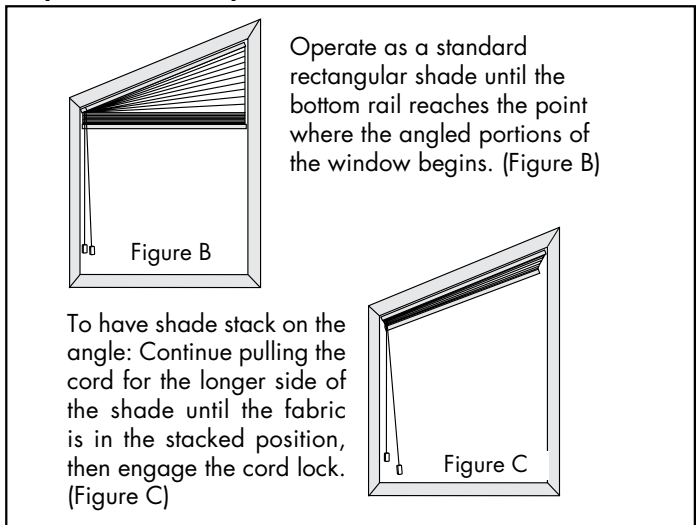

Octagon Operation

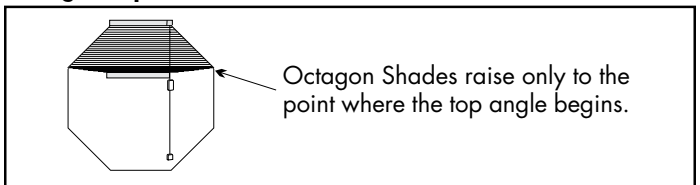

Figure D



CELLULAR HARDWARE

Cellular Specialty Shades

SOPRANO SKYLIGHTS AND GREENHOUSE SHADES HARDWARE SYSTEM

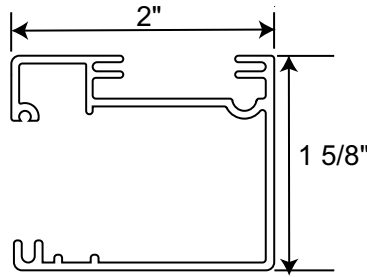

Soprano Rail Dimensions

- Depth of rail: 2"
- Height of rail: 1 5/8"

Hardware Features	
Hardware colors	<ul style="list-style-type: none"> • White head, bottom rail with white gear track retainer. • Bronze head, bottom rail with bronze gear track retainer.
Mounting Dimensions	Soprano Skylights and Greenhouse Shades
Minimum depth required for installation	1 1/2"
Minimum Flush Inside Mount (Rail Fully Recessed)	2 3/8"
Minimum Flush Inside Mount (Handle Fully Recessed)	3"
Deductions	
	Total deduction on the bottom moving rail is 3/4"
	Total deduction on the top rail is 1 1/2"
Finished Dimensions	
Inside Mount	
	<ul style="list-style-type: none"> • Fabric will measure ordered width less: 3/8" • Head rail* will measure ordered width less: 3/16"
* Head rail measurements include endcaps. Width and length measurements may vary +/- 1/8"	

CELLULAR HARDWARE

Applications

- Soprano Skylights
- Soprano Greenhouses

Soprano Shades are for inside mount applications only.

Ordering Information for Soprano Skylights and Greenhouse Shades

- Specify White or Bronze Rails.
- For Greenhouse Shades, supply measurements for: straight top section, curved section and vertical straight section when ordering.

Accessories

- Two Moving Rails*
- 6' Expandable Pole
- 12' Expandable Pole



Specially designed pole end fits into the handle of Soprano shades for easy operation at any angle.

*This option allows you to move shade up from the bottom or down from the top. For ultimate control of light and privacy. See page 10 for upgrade pricing.

Skylight Installation Angles

- For inside mount applications on straight (planar) runs.
- Minimum Installation angle of 5 degrees.
- Maximum installation angle of 85 degrees.
- Horizontal (0 degrees) and vertical (90 degrees) applications are not recommended.

Cellular Specialty Shades

SOPRANO SKYLIGHTS AND GREENHOUSE SHADES HARDWARE SYSTEM

Soprano Skylight Features (Figure A)

- Soprano Shades feature a polycarbonate track system. The hidden gear track allows for smooth operation of the shade and controls light.
- The gear track retainer is White or Bronze to match the moving bottom rail. **Please specify rail color when ordering.**

Soprano Greenhouse Shades Features (Figure B)

- See Figure C below for Greenhouse shade ordering information.
- Soprano Shades are for inside mount applications only.
- **All greenhouse orders require a completed and signed greenhouse shade order form.** Orders must be mailed or faxed to Comfortex for processing. Download a copy at www.comfortex.com/comfortex-dealers or from the OnDemand Library Mobile Library.
- Soprano Shades feature a polycarbonate track system. The hidden gear track allows for smooth operation of the shade and controls light.
- The gear track retainer is White or Bronze to match the moving bottom rail. **Please specify rail color when ordering.**

Soprano Skylights

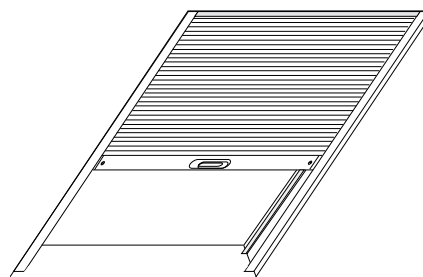

Figure A

Soprano Greenhouses

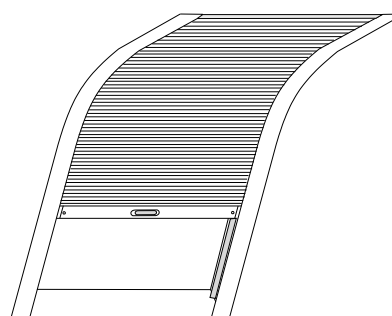
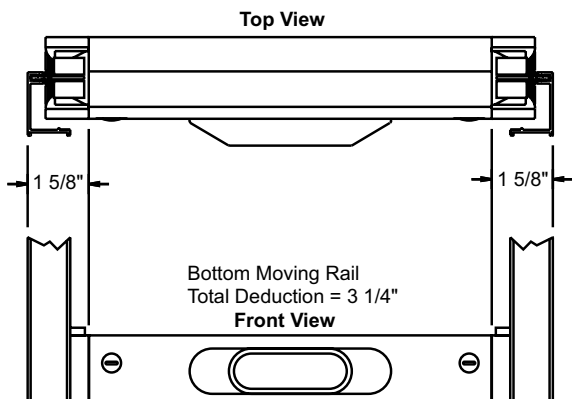
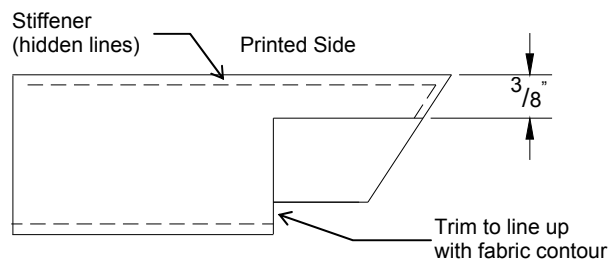

Figure B



Soprano Skylights and Greenhouses Moving Rail
Top and Front View

Soprano Fabric Notch



Additional trimming for bottom stiffener (and attached single layer of fabric).

Greenhouse Ordering Information Figure C

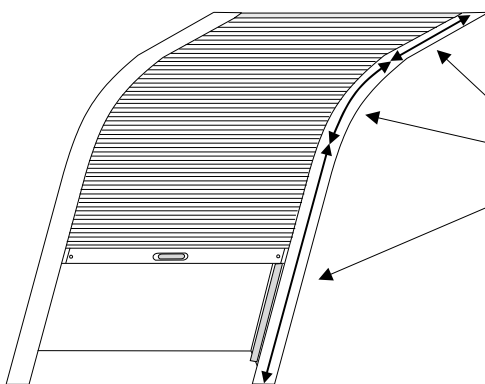

The side rails for greenhouse shades are notched at the curve in the factory. Please supply measurements for:
 Straight top section,
 Curved section and
 Vertical straight section when ordering.

CELLULAR HARDWARE

Cellular Specialty Shades

BALCONY SHADING HARDWARE SYSTEM

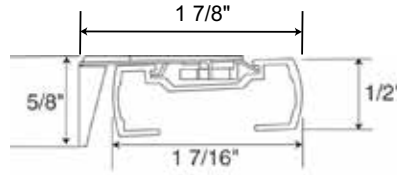
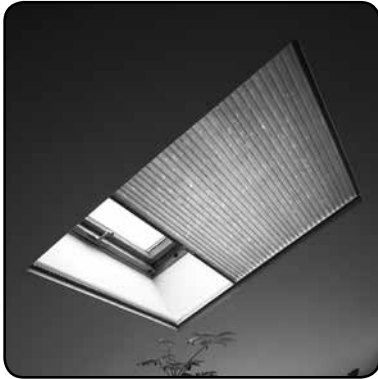

Balcony Rail Dimensions

- Depth of rail: 1 7/16"
- Depth of rail and bracket: 1 7/8"
- Height of rail: 1/2"

Hardware Features	
Hardware colors for all fabrics	Color coordinated head and bottom rails with white cord in a white sidetrack.
Upgrades	
Fabric Wrapped Upgrade	Fabric wrapped head and bottom rails. Fabric used is same fabric as the shade. Back of rail is white to outside.
Designer Metallic Upgrade	<ul style="list-style-type: none"> • Designer Oil Rubbed Bronze head and bottom rails with white cord in a white sidetrack. • Designer Brushed Nickel head and bottom rails with white cord in a white sidetrack.
Mounting Dimensions - Inside Only	
Balcony Shading System	
Minimum required for installation	1 1/4"
Minimum Flush Inside Mount (Rail Fully Recessed)	2 1/4"
Minimum Flush Inside Mount (Handle Fully Recessed)	2 1/16"
The widest width of the window cannot exceed the narrowest width of the window by more than 3/8".	
Finished Dimensions	
Inside Mount	
	<ul style="list-style-type: none"> • Fabric will measure ordered width less: 3/8" • Head rail* will measure ordered width less: 3/16"
* Head rail measurements include endcaps. Width and length measurements may vary +/- 1/8"	

Applications

- Horizontal, Angled and Vertical rectangular windows and skylights. Balcony Shading Systems are for inside mount applications only.

Ordering Information for Balcony Shading System

- Specify rail color.
- Specify when ordering: Application angle: Angled, Horizontal or Vertical.

Accessories

- 6' Expandable Pole
- 12' Expandable Pole



Specially designed pole end fits into the handle of Balcony shades for easy operation at any angle.

CELLULAR HARDWARE

Cellular Specialty Shades

BALCONY SHADING HARDWARE SYSTEM

Balcony Shading System Features

- Balcony Shades work in three orientations applications: Angled, Horizontal and Vertical.
Horizontal works on slope angles 0 to 15 degrees.
Angled works on slope angles 15 to 75 degrees.
Vertical works on slope angles 75 to 90 degrees.
- Balcony shades can be mounted on their side. (See Figure A). Use the vertical measurement as your width (max. 36") and the horizontal measurement as your length (max. 48").
- Polycarbonate track system provides superior insulation and light blocking. The enclosed sides provide full privacy.
- No exposed cords, eliminates risk of injury to children.

Balcony Vertical Applications

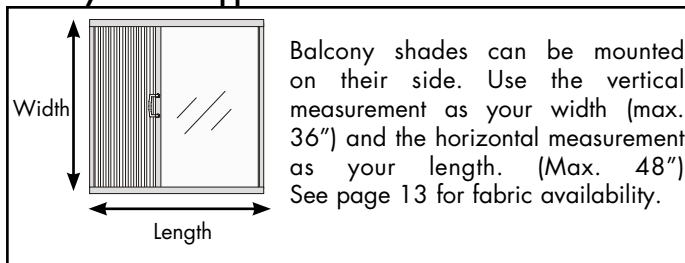

Figure A

Maximum Shade Area

Maximum shade areas (in square feet) varies with slope and fabric type.

	Horizontal	Angled	Vertical
Symphony (All)	24	24	18
Debut Light Filtering (All)	24	24	18
Virtuoso (All)	24	24	18

CELLULAR HARDWARE



Cellular Specialty Shades

MEZZO MOTORIZED SKYLIGHT HARDWARE SYSTEM

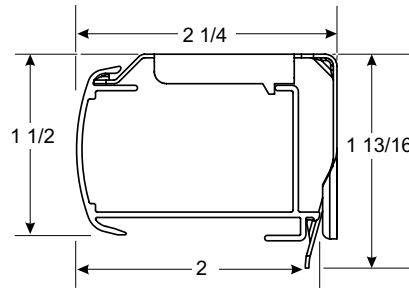

Simplicity Motorized Rail Dimensions

- Depth of rail: 2"
- Depth of rail and bracket: 2 1/4"
- Height of rail: 1 1/2"
- Height of bracket: 1 13/16"

Hardware Features

Hardware colors	White head, bottom and side rails
Simplicity Remotes	Upper and lower limit stops pre-programmed, Intermediate stop "favorites" position can be programmed on-site, 5 Channel, 6 Channel Timer or 14 Channel remote options

Mounting Dimensions	Mezzo Motorized Skylight Shades
Minimum Flush Inside Mount	2 1/2"
	<ul style="list-style-type: none"> • Should not be more than 1/2" out of square to perform as intended • The widest width of the window cannot exceed the narrowest width of the window by more than 3/8". • The shade must be mounted with the fabric stack at the bottom or the lowest point of the window
	See page 78 for Solar Panel Mounting information.

Finished Dimensions

Inside Mount	
	<ul style="list-style-type: none"> • Fabric will measure ordered width less: 1 1/4" • Head rail* will measure ordered width less: 3/16"

* Head rail measurements include endcaps. Width and length measurements may vary +/- 1/8"

MOTORIZATION - HARDWARE UPGRADE SURCHARGES AND ACCESSORIES All standard discounts apply to motorized shades	ADD
Simplicity - Motor and Battery Wand	\$368
Simplicity 5 Channel Remote	\$44
Simplicity 6 Channel Remote with Timer	\$72
48" Extension Wire:	\$19
Simplicity Smart Controller (NEO)	\$363
7.4v Solar Panel & Mounting Brackets	\$110
DC Power Supply	\$70

Applications

- Horizontal, Angled and Vertical motorized skylight shades.
- Mezzo Motorized Skylight Shades are for inside mount applications only.

Ordering Information for Mezzo Motorized Skylight Shades

- Specify inside mount dimensions.
- Specify fabric color and style.
- Specify remote and other accessories if needed.

CELLULAR HARDWARE

Cellular Specialty Shades

MEZZO MOTORIZED SKYLIGHT HARDWARE SYSTEM

Applications

- Horizontal, Angled and Vertical motorized skylight shades.

Mezzo Motorized Skylight Shades are for inside mount applications only.

Mezzo Power Options

- Simplicity Rechargeable Motor

RECHARGEABLE SIMPLICITY MOTORS

The Simplicity Motor program features a battery powered motor utilizing a rechargeable battery hidden inside the shade head rail. Simplicity motors are compact and use a radio frequency remote to raise or lower the shades.

Simplicity Rechargeable Battery

The rechargeable battery is concealed in the head rail of the shade. A charger is required for the rechargeable battery. The rechargeable battery comes fully charged from the factory.



Charging Port on Back of Head rail.

Simplicity Hand Held Remotes

The **5 Channel (5C) remote** can operate up to five shades individually or 5 groups. Simplicity Rechargeable Motorized Cellular Shades are programmed at the factory with the "up and down" limits. The shades are **UNLINKED** from the remote so they are not able to operate during shipping. Each shade should be installed **after** linking it to the remote.

Simplicity 5C remotes and holders are white or black in color. The remote comes with a holder which can be mounted to a wall for easy storage. The range of the remote is approximately 80 feet.

A **6 Channel (6C) timer remote** is also available. See page 65 for more information

Simplicity remotes and holders are black in color. The remote comes with a holder which can be mounted to a wall for easy storage. The range of the remote is approximately 80 feet.

14 Channel White Remote also available (page 56)

The Simplicity remote utilizes one 3V battery (CR2032). Batteries are included. Comfortex will warranty batteries for up to 3 months from date of purchase.



Solar Panel Recharge Option

Plugs in to any Simplicity Rechargeable Remote control shade (does not work with PowerTouch)

Provides constant trickle charge to 7.4v Li-Ion Rechargeable battery packs. Does not require direct sunlight, but performs best in regular direct sunlight applications. Will prolong the life of the charge of the 7.4v rechargeable battery packs, and in some applications will maintain charge indefinitely.

Life of charge is subject to application variables such as, size and weight of shade, frequency of use, amount of direct sunlight exposure, etc.



Solar Recharge Optimum Application

- Full direct sunlight (minimum 4-6 hours per day) to maintain full charge. Based on one operation cycle per day (one open, one close).
- Solar panel will charge batteries even without direct sunlight. Ambient light will charge the batteries but at a slower rate.
- Excessive duration of cloudy weather will impact the rate of charge.

Battery Charger

8.4 Volt charger requires a standard power outlet to recharge the battery wand. Must specify charger when ordering a Simplicity Rechargeable Wand Shade. The charger plugs into the charger port. The charger is black and comes with a 156" wire. The dimensions are 1" wide x 2 1/2" length x 1 3/4" deep.



CELLULAR HARDWARE

Cellular Specialty Shades MEZZO MOTORIZED SKYLIGHT HARDWARE SYSTEM

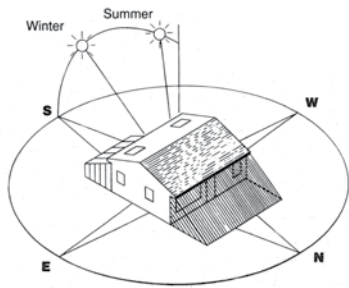

For Locations North of Washington, DC (39° Latitude)





For Locations South of Washington, DC (39° Latitude)



- Assumptions:** 1) Window area free from shadows 9 AM to 3 PM.
2) Glazing is double pane, clear.

Excessive shading or tinted glass will impact the solar charging capability of the system.

-  Indicates orientations which may require periodic manual recharge with Plug In Charger.
-  Indicates orientations which are optimum for solar recharge (wireless systems).

Retrofit Existing Standard Simplicity Motorized Shades with Rechargeable Batteries

Cellular shades made with Standard Simplicity Motorization can be retrofitted with the Rechargeable Simplicity Motorization Battery Wand. The Rechargeable battery wand is 22" long, comes with 10 NiMH batteries, and is white in color. Battery wands are charged at the factory.



Battery Wand for Rechargeable Simplicity Retrofit

See page 55 for further details. Please contact customer service for more information. Does not work with solar panel.

Important Simplicity Motorized Shades Operating and Installation Information

- Simplicity Motorized Shades installed into windows with metal casings may have a reduced radio frequency range, or may not operate at all, depending on the application.
- Do not let the antenna on the motor touch any metal objects. This may interfere with signals from the remote control.

CELLULAR HARDWARE



Cellular Specialty Shades

FRENCH DOOR DÉCOR HARDWARE SYSTEM



Standard Head Rail

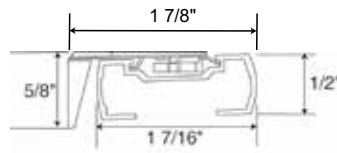

Deluxe Head Rail

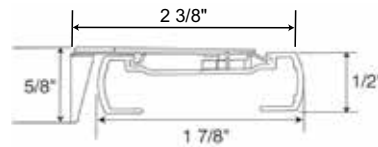

Standard Rail

- Depth of rail: 1 7/16"
- Depth of rail and bracket: 1 7/8"
- Height of rail: 1/2"
- Height of bracket: 5/8"

Deluxe Rail

- Depth of rail: 1 7/8"
- Depth of rail and bracket: 2 3/8"
- Height: 1/2"
- Height of bracket: 5/8"

CELLULAR HARDWARE

Hardware Features	
Hardware colors	Color coordinated head, middle, bottom rails and end caps
Upgrades	
Fabric Wrapped Upgrade	Fabric used is same fabric as the shade. Back of rail is white to outside. Color coordinated end caps
Designer Metallic Upgrade	<ul style="list-style-type: none"> • Oil Rubbed Bronze head, middle, bottom rails and end caps. • Brushed Nickel head, middle, bottom rails and end caps.

Mounting Dimensions	Standard Rail	Deluxe Rail
Minimum Shallow Mount	3/4"	3/4"
Minimum Flush Inside Mount	2"	2 1/2"
Minimum Flush Inside Mount (Handle Fully Recessed)	2 9/16"	3"
Minimum Outside Mount	3/4"	3/4"
Minimum Side Mount	1 1/8"	1 3/8"

The widest width of the window cannot exceed the narrowest width of the window by more than 3/8".

Recommended Side Mounting Method	<ul style="list-style-type: none"> • See page 68 for recommended mounting method for side mount shades • Width limit for side mount brackets is 48"
---	---

Finished Dimensions

Inside and Side Mount	
	<ul style="list-style-type: none"> • Fabric will measure ordered width less: 3/8" • Head rail* will measure ordered width less: 3/16"
Outside Mount	
	<ul style="list-style-type: none"> • Fabric will measure ordered width • Head rail* will measure ordered width plus: 3/16"
Exact (End Cap to End Cap) Mount	
	<ul style="list-style-type: none"> • Fabric will measure ordered width less: 3/16" • Head rail* will measure ordered width

* Head rail measurements include endcaps. Width and length measurements may vary +/- 1/8"

Cellular Specialty Shades

FRENCH DOOR DÉCOR HARDWARE SYSTEM

Applications

- Stationary Door Décor
- Movable Door Décor
- Top Down - Bottom Up Door Décor
- Cover french doors, transoms, and side lights.

French Door Décor Hardware Features

- Features two non-moving rails which are mounted in the window or door. A tension control system enables the movable rail to be easily moved with the touch of a finger. The only visible cords are the ones that hold the movable middle rail in place.
- The widest width of the window cannot exceed the narrowest width of the window by more than $\frac{3}{8}$ ".

Stationary Non-Movable French Door Décor Shades

- Top and bottom rails are mounted to the window and are stationary.

Movable French Door Décor Shades

- Top and bottom rails are mounted to the window, one middle movable rail raises from the bottom.

Top Down - Bottom Up Option

- Top and bottom rails are mounted to the window, two movable rails allow the shade to lower from the top and raise from the bottom.
- The non-movable top and bottom rails are attached to the window or door.
- Ideal for entry ways with narrow windows next to doors and other narrow windows that are easily accessible.

Ordering Information for French Door Décor

- Specify IB or OB mount and rail color.
- Specify stationary, movable or Top Down - Bottom Up.

Accessories

- 6' Expandable Pole
- 12' Expandable

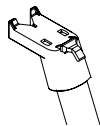

Specially designed pole end allows for easy operation of French Door Décor Shades.

French Door Decor Cellular Shades Hardware

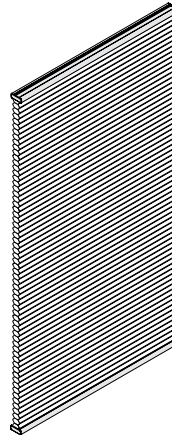

Stationary Non-Movable

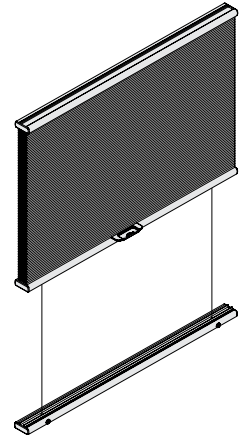

Shown open with movable rail option

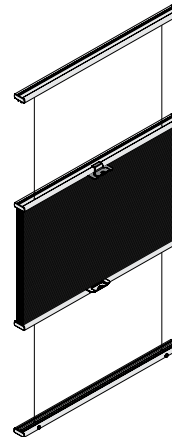

Shown open with Top Down - Bottom Up Option

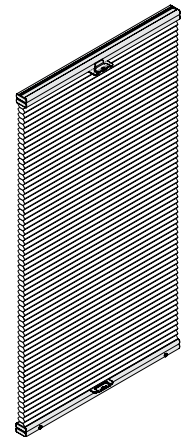

Shown closed with Top Down - Bottom Up Option

CELLULAR HARDWARE

Cellular Specialty Shades

DAY-NIGHT SHADES HARDWARE SYSTEM



Standard Cord Lock Rail

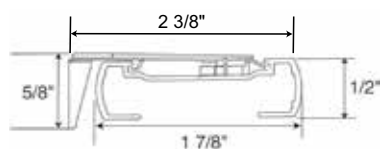
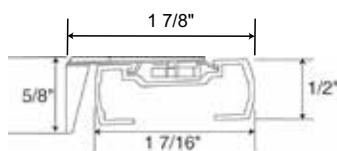

Standard Cord Lock Rail

- Depth of rail: 1 7/16"
- Depth of rail and bracket: 1 7/8"
- Height of rail: 1/2"
- Height of bracket: 5/8"

Deluxe Cord Lock Rail

- Depth of rail: 1 7/8"
- Depth of rail and bracket: 2 3/8"
- Height: 1/2"
- Height of bracket: 5/8"

CELLULAR HARDWARE

Hardware Features		
Hardware colors for all Cellular and Pleated fabrics	Color coordinated head, middle and bottom rails with white cord and tassel. See additional details on page 83.	
Upgrades		
Fabric Wrapped Upgrade	Fabric used is same fabric as the shade. Back of rail is white to outside. Color coordinated end caps.	
Designer Metallic Upgrade	<ul style="list-style-type: none"> • Oil Rubbed Bronze head and bottom rails with bronze colored tassel, end caps and white cord. • Brushed Nickel head and bottom rails and end caps with coordinating tassel and white cord. 	
Mounting Dimensions		
Mounting Method	Standard Rail	Deluxe Rail
Minimum Shallow Mount	3/4"	3/4"
Minimum Flush Inside Mount	2"	2 3/8"
Minimum Outside Mount	3/4"	3/4"
Minimum Side Mount	1 1/8"	1 3/8"
Recommended Side Mounting Method	<ul style="list-style-type: none"> • See page 68 for recommended mounting method for side mount shades • Width limit for side mount brackets is 48" 	
Finished Dimensions		
Inside and Side Mount		
	<ul style="list-style-type: none"> • Fabric will measure ordered width less: 3/8" • Head rail* will measure ordered width less: 3/16" 	
Outside Mount		
	<ul style="list-style-type: none"> • Fabric will measure ordered width • Head rail* will measure ordered width plus: 3/16" 	
Exact (End Cap to End Cap) Mount		
	<ul style="list-style-type: none"> • Fabric will measure ordered width less: 3/16" • Head rail* will measure ordered width 	
* Head rail measurements include endcaps. Width and length measurements may vary +/- 1/8"		

Applications

- Standard Rectangular with cellular fabrics only.

Day - Night Shade Specifications

Refer to the appropriate fabric sections for proper pricing.

Fabrics

- Some fabrics (i.e. Symphony Blackout) can be used exclusively only as a bottom panel only.

Cellular Specialty Shades

DAY-NIGHT SHADES HARDWARE SYSTEM

Rail Colors and Cord Colors

- **Color Coordinated Rail Shades:** The top rail and middle rail will coordinate with top fabric and bottom rail will coordinate with the bottom fabric. The cord and tassel will be white. Not available with Color Lux Shades.
- **Designer Metallic Hardware Shades:** All rails, end caps and tassels will be the selected metallic color. Cords will be white.
- **Fabric Wrapped Rail Shades:** The top rail and middle rail will coordinate with top fabric and bottom rail will coordinate with the bottom fabric. The cord and tassel will be white. End caps and cord lock will be color coordinated.

Ordering Information for Day - Night Shade

- Specify fabrics, top and bottom panels.
- Specify IB or OB mount and rail color.

TOP FABRIC

CELLULAR	Width		Length	
	Min	Max	Min	Max
Verona	12"	72"	18"	96"
Boutique	12"	72"	18"	96"
Debut 1/2" Double Cell Light Filtering	12"	72"	18"	96"
Debut 1/2" Single Cell Light Filtering	12"	72"	18"	96"
Debut 3/4" Single Cell Light Filtering	12"	72"	18"	96"
Linen Weave Light Filtering*	12"	72"	18"	96"
Linen Weave Room Darkening*	NA	NA	NA	NA
Premiere 1/2" Single Cell Blackout	NA	NA	NA	NA
Premiere 1/2" Single Cell Light Filtering	12"	72"	18"	96"
Premiere 3/4" Single Cell Blackout	NA	NA	NA	NA
Premiere 3/4" Single Cell Light Filtering	12"	72"	18"	96"
Symphony 3/8" Double Cell Blackout	NA	NA	NA	NA
Symphony 3/8" Double Cell Light Filtering	12"	72"	18"	96"

BOTTOM FABRIC

CELLULAR	Width		Length	
	Min	Max	Min	Max
Verona	12"	72"	18"	96"
Boutique	12"	72"	18"	96"
Debut 1/2" Double Cell Light Filtering	12"	72"	18"	96"
Debut 1/2" Single Cell Light Filtering	12"	72"	18"	96"
Debut 3/4" Single Cell Light Filtering	12"	72"	18"	96"
Linen Weave Light Filtering*	12"	72"	18"	96"
Linen Weave Room Darkening*	12"	72"	18"	96"
Premiere 1/2" Single Cell Blackout	12"	72"	18"	96"
Premiere 1/2" Single Cell Light Filtering	12"	72"	18"	96"
Premiere 3/4" Single Cell Blackout	12"	72"	18"	96"
Premiere 3/4" Single Cell Light Filtering	12"	72"	18"	96"
Symphony 3/8" Double Cell Blackout	12"	72"	18"	96"
Symphony 3/8" Double Cell Light Filtering	12"	72"	18"	96"

* Day-Night Shades can only be built in conjunction with other 3/4" cellular fabrics. All Debut includes print patterns: Strie, Terazzo, Angel Hair, Strat, Florance, Blossom, Country Woven and Homespun.

Cellular Specialty Shades

CUSTOM GRAPHICS

Custom Graphics

With Custom Graphics, you can print anything on a Cellular Shade. From logos to personal photos, theme room graphics or advertising for your storefront, anything you envision can be featured on a Custom Graphics Cellular Shade.

Hardware | Mounting | Finished Dimensions

See Page 48

Available Fabrics

Custom Graphics are available with the following fabrics:

- Premiere 1/2" and 3/4" Light Filtering Fabrics
- Premiere 1/2" and 3/4" Blackout Fabrics

Custom Graphics can work for any window.

Advertising and Store Identification

Contact local businesses and explain how you can turn their window space into advertising!



Decorative and Personal Photos

Customers can now convert their special photos into a highly personalized room!

Printing Information and Options

Custom Graphics will look different from fabric to fabric. The color vibrancy on cellular shades will be muted due to the density of the fabrics and the printing process.

To view the color differences on Cellular Shades, visit the Custom Graphic section of the Comfortex Dealers website.

Single Sided Printing:

Cellular Custom Graphics are available as single-sided only. Double-sided graphics are not available.

You can choose to have Side A face the room side or the street side.



Side A
Shows Printed Image



Side B
White Fabric

Ordering Information for Custom Graphics Cellular Shades

Step 1. Fill out the Custom Graphics Cellular Shades

Order Form. This form includes your fabric and hardware selections. Fax the completed order form to (800) 336-4580 to place your order. Custom Graphic orders can only be placed by faxing this form.

Step 2. Receive your Comfortex Work Order Confirmation

number. Be sure to reference this number when submitting you artwork in Step 3.

Step 3. Send your graphic files via email to:

CustomGraphics@Comfortex.com

Or ship a CD containing your graphics to:

Custom Graphics
Comfortex Window Fashions
21 Elm Street
Maplewood, NY 12189

Graphic File Specifications

Preferred Formats:

- Adobe Illustrator
- EPS

Other Accepted Formats:

- TIFF
- JPEG
- PSD

- All typography should be converted to paths when submitting an Illustrator or EPS file.
- TIFF and JPEG files should be submitted at the largest size possible, 300 DPI is preferred. We will size your graphics according to your shade size and specifications.
- Contact Comfortex Customer Care at 800-843-4151 with all questions regarding Custom Graphic Orders.
- Comfortex will not print any copyrighted custom graphics without appropriate permission.

Step 4. The Custom Graphic Team will email a PDF proof of your shade order for you to approve. Once the artwork is approved, it will take two weeks for your order to be printed, assembled, and shipped.

**Prelude Cellular
STANDARD CORD LOCK SHADES HARDWARE SYSTEM**

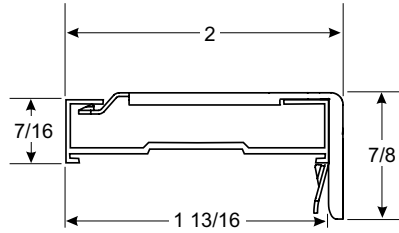

Cord Lock Rail Dimensions

- Depth of rail: 1 13/16"
- Depth of rail and bracket*: 2"
- Height of rail: 7/16"
- Height of bracket: 7/8"

*Depth of rail (including Cord Lock mechanism) and bracket is 2 3/8"

Hardware Features			
Standard Hardware colors for Comfortex Prelude	Color coordinated head, middle and bottom rails with color coordinated cord and tassel.		
Upgrades			
Fabric Wrapped Upgrade	Not Available on Cord Lock Shades		
Designer Metallic Upgrade	Not Available on Cord Lock Shades		
Mounting Dimensions			
	Standard Bracket	Swivel Bracket	End Mount Bracket
Minimum Depth Inside Mount	1 1/4"	1/2"	NA
Minimum Flush Inside Mount	2 1/4"	2"	2"
Minimum Outside Mount	1"	1"	1"
Maximum End Mount Shade width 36"			
Finished Dimensions			
Inside Mount			
	<ul style="list-style-type: none"> Fabric will measure ordered width less: 3/8" Head rail* will measure ordered width less: 3/16" Length will measure ordered length 		
Outside Mount			
	<ul style="list-style-type: none"> Fabric will measure ordered width Head rail* will measure ordered width plus: 3/16" Length will measure ordered length 		
Cord Length			
	<ul style="list-style-type: none"> Comfortex complies with all WCMA/ANSI standards and as such the default cord length will be 40% of the ordered shade length. Custom lengths are available. 		
* Head rail measurements include endcaps. Width and length measurements may vary +/- 1/8"			
NOTE: An additional 1/4" width deduction is taken on shades ordered Inside Mount with hold down brackets.			

PRELUDE HARDWARE

Prelude Cellular

STANDARD CORD LOCK SHADES HARDWARE SYSTEM

Applications

- Standard Rectangular
- Top Down - Bottom Up
- Two-On-One Head Rail

Things to Consider

- If child or pet safety is a concern, consider Cordless Ultra.
 - Larger shades can be difficult to operate. Consider Cord Loop hardware.
 - If privacy is an issue, consider Top Down-Bottom Up options.
-

Ordering Information for Standard Cord Lock Shades

Standard Rectangular

- Specify IB or OB mount, and left or right lift cord.

Top Down - Bottom Up

- Specify IB or OB mount.
Top Down - Bottom Up Shades are made with two operating cord locks, one on the left and one on the right side of shade. The right cord operates the middle rail and left cord operates the bottom.
- On Top Down - Bottom Up Shades, an extra two-cell fabric gasket attached to the top head rail and acts as a seal to eliminate light leakage between the head rail and middle rail when the shade is closed.

Two-On-One Head Rail

Two-On-One Head Rail Shades operate as two separate shades on one head rail.

- Specify IB or OB mount.
- Specify panel sizes.
- Maximum width in a single panel depends on fabric type. See page 2 for maximum single panel width.
- ¼" to maximum ½" Space between panels.



**Prelude Cellular
CORD LOOP HARDWARE SYSTEM**

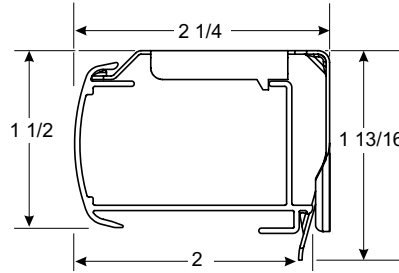

Cord Loop Rail Dimensions

- Depth of rail: 2"
- Depth of rail and bracket: 2 1/4"
- Height of rail: 1 1/2"
- Height of bracket: 1 13/16"

Hardware Features	
Standard Hardware colors for Comfortex Prelude	Color coordinated head, bottom rails and end caps with a white cord and tensioner
Upgrades	
Fabric Wrapped Upgrade	Fabric used is same fabric as the shade. Back of rail is white to outside. Color coordinated end caps for rails.
Designer Metallic Upgrade	<ul style="list-style-type: none"> • Smooth faced Oil Rubbed Bronze head, bottom rails and end caps with bronze tensioner and bronze cord. • Smooth faced Brushed Nickel head, bottom rails and end caps with coordinating tensioner and cord.
Mounting Dimensions	Cord Loop Hardware System
Minimum Inside Mount	3/4"
Minimum Flush Inside Mount	2 1/8"
Minimum Outside Mount Flat Vertical Surface	1 1/2"
Maximum End Mount Shade width 48"	

Finished Dimensions -Standard Rectangular and Top Down-Bottom Up	
Inside Mount	
	<ul style="list-style-type: none"> • Fabric will measure ordered width less: 3/8" • Head rail* will measure ordered width less: 1/4" • Length will measure ordered length
Inside Mount with Hold Down Brackets	
	<ul style="list-style-type: none"> • Fabric will measure ordered width less: 5/8" • Head rail* will measure ordered width less: 1/2" • Bottom rail* will measure ordered width less: 1/2" • Length will measure ordered length
Outside Mount	
	<ul style="list-style-type: none"> • Fabric will measure ordered width less: 1/8" • Head rail* will measure ordered width • Length will measure ordered length
* Head rail measurements include endcaps. Width and length measurements may vary +/- 1/8"	

NOTE: An additional 1/4" width deduction is taken on shades ordered Inside Mount with hold down brackets.

PRELUDE HARDWARE

**Prelude Cellular
CORD LOOP HARDWARE SYSTEM**

Finished Dimensions -Two-On-One	
Inside Mount	
	<ul style="list-style-type: none"> • Fabric will measure ordered width less: $\frac{5}{8}$" • Head rail* will measure ordered width less: $\frac{1}{4}$" • Length will measure ordered length
Outside Mount	
	<ul style="list-style-type: none"> • Fabric will measure ordered width less: $\frac{1}{8}$" • Head rail* will measure ordered width • Length will measure ordered length
<p>* Head rail measurements include endcaps. Width and length measurements may vary +/- $\frac{1}{8}$"</p>	

NOTE: An additional $\frac{1}{4}$ " width deduction is taken on shades ordered Inside Mount with hold down brackets.

Applications

- Standard Rectangular
- Top Down - Bottom Up
- Two-On-One Head Rail

Cord Loop Hardware System Features

Cord loops are available 18" to 10' lengths. Please specify length when ordering. Standard loop sizes are as follows:

Shade Length	Standard Loop
Up to 18"	18"
18" to 42"	2' (24")
42 $\frac{1}{8}$ " to 54"	3' (36")
54 $\frac{1}{8}$ " to 72"	4' (48")
72 $\frac{1}{8}$ " to 90"	5' (60")
90 $\frac{1}{8}$ " to 110"	6' (72")
110 $\frac{1}{8}$ " and greater	8' (96")

Ordering Information for Cord Loop Hardware Shades

Standard Rectangular

- Specify IB or OB mount, and left or right cord loop.
- Specify cord loop length when ordering.

Top Down - Bottom Up

- Specify IB or OB mount.
Specify cord loop length when ordering.
- Controls are the right cord loop operates the middle rail and left cord loop operates the bottom. Reverse controls are not available.

Two-On-One Head Rail

- Two-On-One Head Rail Shades operate as two separate shades on one head rail.
- Specify IB or OB mount.
- Specify panel sizes.
- Specify cord loop length when ordering.
- See page 2 for maximum single panel width.
- $\frac{1}{4}$ " Space between panels.

**Prelude Cellular
CORDLESS ULTRA HARDWARE SYSTEM**

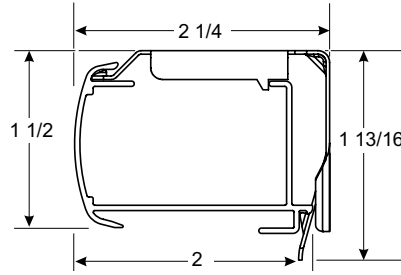
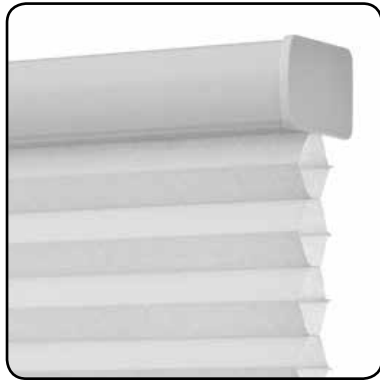

Cord Loop Rail Dimensions

- Depth of rail: 2"
- Depth of rail and bracket: 2 1/4"
- Height of rail: 1 1/2"
- Height of bracket: 1 13/16"

Hardware Features	
Standard Hardware colors for Comfortex Prelude	Color coordinated head, middle and bottom rails.
Upgrades	
Fabric Wrapped Upgrade	Fabric used is same fabric as the shade. Back of rail is white to outside. End caps on fabric wrapped head, middle and bottom rails are color coordinated
Designer Metallic Upgrade	<ul style="list-style-type: none"> • Smooth faced Designer Oil Rubbed Bronze head, middle, bottom rails and end caps • Smooth faced Designer Brushed Nickel head, middle, bottom rails and end caps
Mounting Dimensions	
	Cordless Ultra Hardware System
Minimum Inside Mount	3/4"
Minimum Flush Inside Mount	2 1/8"
Minimum Outside Mount Flat Vertical Surface	1 1/2"
Maximum End Mount Shade width 48"	
Finished Dimensions	
Inside Mount	
	<ul style="list-style-type: none"> • Fabric will measure ordered width less: 3/8" • Head rail* will measure ordered width less: 1/4" • Length will measure ordered length
Inside Mount with Hold Down Brackets	
	<ul style="list-style-type: none"> • Fabric will measure ordered width less: 5/8" • Head rail* will measure ordered width less: 1/2" • Bottom rail* will measure ordered width less: 1/2" • Length will measure ordered length
Outside Mount	
	<ul style="list-style-type: none"> • Fabric will measure ordered width less: 1/8" • Head rail* will measure ordered width • Length will measure ordered length
End Mount/Side Mount	
	<ul style="list-style-type: none"> • Fabric will measure ordered width less: 5/8" • Head rail* will measure ordered width less: 1/2" • Length will measure ordered length
* Head rail measurements include endcaps. Width and length measurements may vary +/- 1/6"	

NOTE: An additional 1/4" width deduction is taken on shades ordered Inside Mount with hold down brackets.

PRELUDE HARDWARE

Prelude Cellular CORDLESS ULTRA HARDWARE SYSTEM

Applications

- Standard Rectangular
- Top Down - Bottom Up
- Two-On-One Head Rail
- Three-On-One Head Rail

Ordering Information for Cordless Ultra Hardware Shades

Standard Rectangular

- Specify IB or OB mount.

Top Down - Bottom Up

- Specify IB or OB mount.

Accessories

- 6' Expandable Pole 

Specially designed pole end fits into the handle on the bottom rail and allows for easy operation.

Things to Consider

- Is the top of your window out of reach? You can order an extension pole to reach but it can still be tricky. You may want to consider Cord Loop hardware.
- For shades mounted on doors, you may want to order hold down brackets.
- If privacy is an issue, consider Top Down-Bottom Up options.

CORDLESS THREE-ON-ONE SIZE STANDARDS*	
Minimum Width (per panel)	16"
Minimum Width (Overall)	48"
Maximum Width (per panel)	120"
Maximum Width (Overall)	174"
Minimum Height	12"
Maximum Height	84"
Maximum Area (per panel) (Sq/Ft)	70

*Three-On-One head rail is not available in Top Down-Bottom Up



PRELUDE HARDWARE

**Prelude Cellular
CORDLESS LIFT & LOCK HARDWARE SYSTEM**

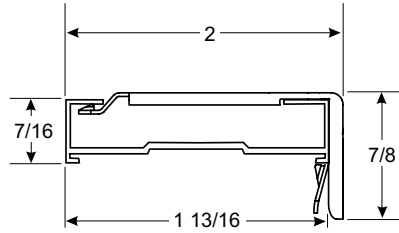

Cord Lock Rail Dimensions

- Depth of rail: 1 13/16"
- Depth of rail and bracket: 2"
- Height of rail: 7/16"
- Height of bracket: 7/8"

Hardware Features	
Standard Hardware colors for Comfortex Prelude	Color coordinated head, middle and bottom rails with color coordinated push button/handle on the middle and/or bottom rails
Upgrades	
Fabric Wrapped Upgrade	Fabric used is same fabric as the shade. Back of rail is white to outside. All shades will have a white push button/handle on the middle /bottom rail. White end caps.

Mounting Dimensions	Standard Head Rail
Minimum Inside Mount	3/4"
Minimum Flush Inside Mount	2 1/8"
Minimum Outside Mount Flat Vertical Surface	1 1/2"
Maximum End Mount Shade width 48"	

Finished Dimensions

Inside Mount	
	<ul style="list-style-type: none"> • Fabric will measure ordered width less: 3/8" • Head rail* will measure ordered width less: 3/16"
Outside Mount	
	<ul style="list-style-type: none"> • Fabric will measure ordered width less: 1/8" • Head rail* will measure ordered width
End Mount/Side Mount	
	<ul style="list-style-type: none"> • Fabric will measure ordered width less: 1/2" • Head rail* will measure ordered width less: 1/2"
* Head rail measurements include endcaps. Width and length measurements may vary +/- 1/8"	

NOTE: An additional 1/4" width deduction is taken on shades ordered Inside Mount with hold down brackets

PRELUDE HARDWARE

**Prelude Cellular
CORDLESS LIFT & LOCK HARDWARE SYSTEM**

Applications

- Standard Rectangular
- Top Down - Bottom Up
- Two-On-One Head Rail
- Three-On-One Head Rail

**Ordering Information for Cordless Lift & Lock Hardware Shades
Standard Rectangular**

- Specify IB or OB mount and rail color.

Top Down - Bottom Up

- Specify IB or OB mount.

Things to Consider

- To operate a Cordless Lift & Lock Shade, the middle or bottom rails must be accessible. An extension pole is not available for Cordless Lift & Lock Shades.
- For shades mounted on doors, you may want to order hold down brackets.
- If privacy is an issue, consider Top Down-Bottom Up options.

Cordless Lift & Lock Shade Operation

Cordless Lift & Lock Shades are operated using the push button handle located in the center of the bottom rail.

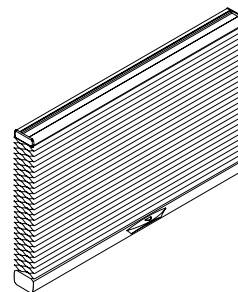

To raise or lower the shade; press the button on the shade handle, and guide the rail to desired position. Release the button to lock the shade into place.

The shade will hold any position when the button is released. Raise the shade slowly and steadily to allow the shade to stack evenly.

CORDLESS THREE-ON-ONE SIZE STANDARDS*	
Minimum Width (per panel)	16"
Minimum Width (Overall)	48"
Maximum Width (per panel)	120"
Maximum Width (Overall)	174"
Minimum Height	12"
Maximum Height	84"
Maximum Area (per panel) (Sq/Ft)	70

*Three-On-One head rail is not available in Top Down-Bottom Up



PRELUDE HARDWARE

Prelude Cellular
RECHARGEABLE SIMPLICITY MOTORIZED HARDWARE SYSTEM

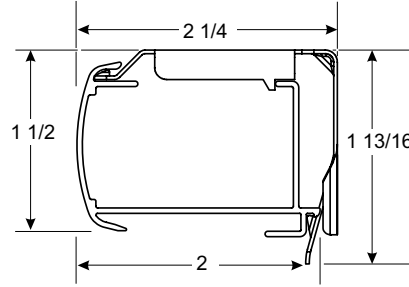

Rechargeable Simplicity Rail Dimensions

- Depth of rail: 2"
- Depth of rail and bracket: 2 1/4"
- Height of rail: 1 1/2"
- Height of bracket: 1 13/16"

Hardware Features	
Hardware colors for all Cellular and Pleated fabrics (Symphony Blackout Not Available)	Color coordinated head, bottom rails and end caps
Standard Hardware for all Custom Graphics	White head and bottom rails and end caps
Upgrades	
Fabric Wrapped Upgrade	Fabric used is same fabric as the shade. Back of rail is white to outside. End caps on fabric wrapped head and bottom rails are color coordinated
Designer Metallic Upgrade	<ul style="list-style-type: none"> • Smooth faced Oil Rubbed Bronze head, bottom rails and end caps • Smooth faced Brushed Nickel head, bottom rails and end caps

Mounting Dimensions	Rechargeable Simplicity Motorization Hardware System
Minimum Shallow Mount	1/2"
Minimum Flush Inside Mount	2 1/4"
Minimum Outside Mount	7/8"
Minimum Side Mount	1 1/4"
Minimum Flush Side Mount	2 1/4"
Recommended Side Mounting Method	<ul style="list-style-type: none"> • See page 68 for recommended mounting method for side mount shades • Width limit for side mount brackets is 48"

Finished Dimensions	
Inside Mount	
	<ul style="list-style-type: none"> • Fabric will measure ordered width less: 3/8" • Head rail* will measure ordered width less: 3/16"
Outside Mount	
	<ul style="list-style-type: none"> • Fabric will measure ordered width • Head rail* will measure ordered width plus: 3/16"
Side Mount	
	<ul style="list-style-type: none"> • Fabric will measure ordered width less: 7/8" • Head rail* will measure ordered width less: 1 1/16"
Exact (End Cap to End Cap) Mount	
	<ul style="list-style-type: none"> • Fabric will measure ordered width less: 3/16" • Head rail* will measure ordered width
* Head rail measurements include endcaps. Width and length measurements may vary +/- 1/8"	

PRELUDE HARDWARE

Prelude Cellular

RECHARGEABLE SIMPLICITY MOTORIZED HARDWARE SYSTEM

Rechargeable Simplicity Motors

The Simplicity Motor program features a battery powered motor utilizing a rechargeable battery hidden inside the shade head rail. Simplicity motors are compact and use a radio frequency remote to raise or lower the shades.

Rechargeable Motorized Lift Systems are not offered on sizes within the shaded area on the Standard Rectangular price grids.

Applications

- Standard Rectangular

EZ Level

Learn about the EZ Level feature on page 116.

Rechargeable Simplicity Motorization Surcharges

The Rechargeable Simplicity Motorized Lift System surcharge includes a rechargeable battery. Remotes are needed to operate the shades. Refer to pricing pages.

Important Simplicity Motorized Shade Operating and Installation Information

- Simplicity Motorized Shades installed into windows with metal casings may have a reduced radio frequency range, or may not operate at all, depending on the application.
- Do not let the antenna on the motor touch any metal objects. This may interfere with signals from the remote control.

RECHARGEABLE SIMPLICITY PRICING EXAMPLE:

Linen Weave	
Light Filtering 42" x 60" Shade:	\$383.00
Simplicity Rechargeable Surcharge:	\$368.00
Charger for Rechargeable :	\$30.00
Simplicity Remote Control:	\$44.00
Total List Price:	\$825.00

Simplicity Rechargeable Battery

The rechargeable battery is concealed in the head rail of the shade. A charger is required for the rechargeable battery. The rechargeable battery comes fully charged from the factory.

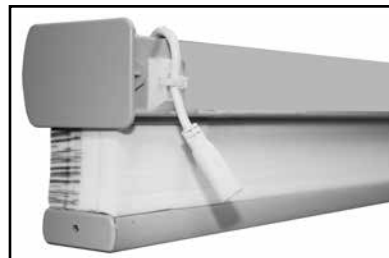

Charging Port on Back of Head rail.

Retrofit Existing Standard Simplicity Motorized Shades with Rechargeable Batteries

Cellular shades made with Standard Simplicity Motorization can be retrofitted with the Rechargeable Simplicity Motorization Battery Wand. The Rechargeable battery wand is 22" long, comes with 10 NiMH batteries, and is white in color. Battery wands are charged at the factory.

To retrofit the rechargeable battery wand to an existing shade with a cassette head rail, you must have at least 24" between bracket centerlines to fit the battery wand. Otherwise, the wand must be placed elsewhere along the window. Wall mounting clips are provided with the wand.

Retrofit Ordering Requirements:

- Rechargeable battery wand with clips (one per shade)
- Rechargeable battery charger (one or more per order, or as needed)
- Charge port mounting base (optional)

Please contact customer service for more information. Does not work with solar panel.



Battery Wand for Rechargeable Simplicity Retrofit

PRELUDE HARDWARE

Prelude Cellular

RECHARGEABLE SIMPLICITY MOTORIZED HARDWARE SYSTEM

Simplicity Rechargeable Battery Life

Rechargeable batteries are included with the motor.

The average battery charge will last 6-12 months based on an average sized shade raised and lowered once per day. The life of the battery charge will vary based on the type of window covering selected, the size and weight of the window covering and the number of times the shade is operated on a daily basis.

The battery can be recharged up to 500 times. It takes approximately 5 hours to recharge the motor when fully depleted.

Ordering Information for Rechargeable Motorized Cellular Shades

Simplicity Motor Option

- Specify IB or OB mount and rail color.
- Specify remote and other accessories if needed.
- Specify one or more battery chargers.

Please Note:

- Not all motors run at the same rate of speed.
- Simplicity motors have a "Favorites" position setting. If the homeowner wants to set several shades at the same intermediate position, follow instructions provided with installation manual.
- Simplicity Rechargeable Motorized Cellular Shades are programmed at the factory with the "up and down" limits. The shades are **UNLINKED** from the remote so they are not able to operate during shipping. Each shade should be installed **after** linking it to the remote.
- **REMEMBER: Order at least one charger if ordering rechargeable motors.**

Simplicity Motorized Shade Warranty

Please see page 122 for complete Comfortex warranty information.

Battery Charger

8.4 Volt charger requires a standard power outlet to recharge the battery wand. Must specify charger when ordering a Simplicity Rechargeable Wand Shade. The charger plugs into the charger port. The charger is black and comes with a 156" wire. The dimensions are 1" wide x 2½" length x 1¾" deep.



Simplicity Motor Hand Held Remotes 5 Channel Remote

The **5 Channel (5C) remote** can operate up to five shades individually or 5 groups. Simplicity Rechargeable Motorized Cellular Shades are programmed at the factory with the "up and down" limits. The shades are **UNLINKED** from the remote so they are not able to operate during shipping. Each shade should be installed **after** linking it to the remote.



Simplicity 5C remotes and holders are white or black in color. The remote comes with a holder which can be mounted to a wall for easy storage. The range of the remote is approximately 80 feet.

Simplicity Motor Hand Held Remotes Operation

Press the up or down button on the remote to raise or lower the shade to your desired position.

To reprogram channel assignments, please refer to the installation instructions and/or view the video at: comfortex.com/comfortex-dealers.

The Simplicity remotes utilize one 3V battery. Batteries are included. Comfortex will warranty batteries for up to 3 months from date of purchase. Batteries are not covered by the warranty.

Solar Panel Recharge Option

Plugs in to any Simplicity Rechargeable Remote control shade (does not work with PowerTouch)

Provides constant trickle charge to 7.4v Li-Ion Rechargeable battery packs. Does not require direct sunlight, but performs best in regular direct sunlight applications. Will prolong the life of the charge of the 7.4v rechargeable battery packs, and in some applications will maintain charge indefinitely.

Life of charge is subject to application variables such as, size and weight of shade, frequency of use, amount of direct sunlight exposure, etc.



Dimensions of panel
18½" x 1½"

Prelude Cellular
POWERTOUCH RECHARGEABLE MOTORIZED HARDWARE SYSTEM

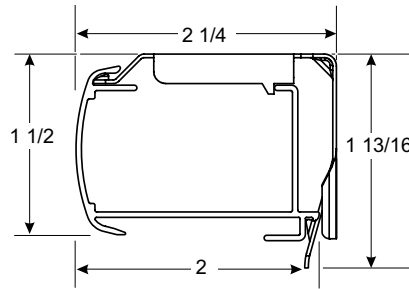

Simplicity Motorized Rail Dimensions

- Depth of rail: 2"
- Depth of rail and bracket: 2 1/4"
- Height of rail: 1 1/2"
- Height of bracket: 1 13/16"

Hardware Features

Hardware colors for all Cellular and Pleated fabrics	Color coordinated head, bottom rails and end caps
Standard Hardware for all Custom Graphics	White head and bottom rails and end caps
PowerTouch Wand	Upper and lower limit stops pre-programmed, Intermediate stop "favorites" position available

Upgrades

Fabric Wrapped Upgrade	Fabric used is same fabric as the shade. Back of rail is white to outside. End caps on fabric wrapped head and bottom rails are color coordinated
Designer Metallic Upgrade	<ul style="list-style-type: none"> • Smooth faced Oil Rubbed Bronze head, bottom rails and end caps • Smooth faced Brushed Nickel head, bottom rails and end caps

PRELUDE HARDWARE

Mounting Dimensions

Simplicity Motorized Hardware System

Minimum Shallow Mount	1/2"
Minimum Flush Inside Mount	2 1/4"
Minimum Outside Mount	7/8"
Minimum Side Mount	1 1/4"
Minimum Flush Side Mount	2 1/4"

Recommended Side Mounting Method

- See page 68 for recommended mounting method for side mount shades
- Width limit for side mount brackets is 48"

Finished Dimensions

Inside Mount

- Fabric will measure ordered width less: 3/8"
- Head rail* will measure ordered width less: 3/16"

Outside Mount

- Fabric will measure ordered width
- Head rail* will measure ordered width plus: 3/16"

Side Mount

- Fabric will measure ordered width less: 7/8"
- Head rail* will measure ordered width less: 1 1/16"

Exact (End Cap to End Cap) Mount

- Fabric will measure ordered width less: 3/16"
- Head rail* will measure ordered width

* Head rail measurements include endcaps. Width and length measurements may vary +/- 1/8"

Prelude Cellular

POWERTOUCHE RECHARGEABLE MOTORIZED HARDWARE SYSTEM

PowerTouch™ Rechargeable Shades

Cellular Shades can be fabricated with the PowerTouch Rechargeable Push Button Control option. The PowerTouch Rechargeable option is an easy, cord free motorized operation for the budget savvy homeowner. PowerTouch Rechargeable uses Simplicity motors and components.

PowerTouch Rechargeable Shades Operation

Press the up or down button on the pendant to raise or lower the shade to your desired position.

No programming is required with PowerTouch™, all programming is set at the factory. Upper and lower limits can easily be adjusted in the field if desired. Please refer to the installation instructions at comfortex.com/ comfortex-dealers.com/. A "favorites" or intermediate stop position can be set once installed.

PowerTouch Rechargeable Surcharges

See page 10.

PowerTouch Appearance

- The PowerTouch wand and pendant is attached to the head rail when installed.
- The wand and pendant hangs down the front of the shades from the head rail. The wand does not touch the fabric.
- Pendant is 2½" long.
- The pendant does not need to be mounted to the wall to operate the shade.



PowerTouch Rechargeable Color Options

- Shades with Black or Oil Rubbed Bronze hardware will be built with black wand and pendants standard. All other colors will use white wand and pendants.



White



Black Shown with Plug-In Charger

PowerTouch Wand and Pendant Location

The standard location for the wand and pendant is on the right. Please specify location when ordering.

PowerTouch Rechargeable Wand Length

- The standard length of the wand will measure the indicated below unless otherwise specified.

Shading Length	Standard Wand Length
Up to 30"	1' (12")
>30" to 52"	2' (24")
>52" to 78"	3' (36")
>78" to 100"	4' (48")
>100" to 120"	5' (60")

Mounting Requirements for PowerTouch Rechargeable Shades

- No special installation hardware or wiring requirements are needed.

Battery Charger

8.4 Volt charger requires a standard power outlet to recharge the battery wand. Must specify charger when ordering a Simplicity Rechargeable Wand Shade. The charger plugs into the charger port. The charger is black and comes with a 156" wire. The dimensions are 1" wide x 2½" length x 1¾" deep.



PowerTouch Rechargeable Shades Warranty

Please see page 122 for complete warranty information.

Prelude Cellular
OVATION CELLULAR SLIDER HARDWARE SYSTEM

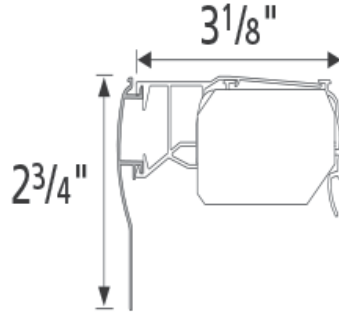

Ovation Hardware Rail Dimensions

- Depth of rail and bracket: 3 1/8"
- Valance Height: 2 3/4"
- For each spacer block 1/2" will be added to the length of the valance returns. For extension brackets, 2" will be added unless otherwise instructed.

Hardware Features	
Standard Hardware colors for Comfortex Prelude	Coordinating rail colors have been preselected for each fabric. More colorful fabrics are coordinated to white and off-white rail colors.
Ovation Valance	Every Ovation Slider comes with a painted aluminum valance. The valance attaches to the head rail using a durable plastic clip system.

Mounting Dimensions	Ovation Hardware System
Minimum Inside Mount, Installation Bracket	1 5/16"
Minimum Flush Mount	3 5/8"
Minimum Outside Mount	5/8"
Mounting Specs	<ul style="list-style-type: none"> • For each spacer block, 1/2" will be added to the length of the valance returns. For extension brackets, 2" will be added unless otherwise instructed. • Specify Inside Mount (IB) or Outside Mount (OB) when ordering. If the slider requires a non-flush inside mount, you must order a custom valance. • Exact valance width and exact valance return length (minimum 1 1/2") must be specified in the Special Instructions section of the order form.

Finished Dimensions

Inside Flush Mount	
Track Width:	
Right or Left Stack	3/16" less than ordered width
Split Stack	3/16" less than ordered width
Center Stack	3/16" less than ordered width
Finished Slider Length	1/2" less than ordered width
Valance	3/16" less than ordered width
Outside Mount	
Track Width	3/16" less than ordered width
Finished Slider Length	Ordered length - No reductions will be made
Valance	Ordered width plus 1"
Valance Returns	Will measure 3 1/8" (standard)

PRELUDE HARDWARE

Prelude Cellular

OVATION CELLULAR SLIDER HARDWARE SYSTEM

Applications

- Standard Rectangular
- Opens and closes from side to side
- Four stacking options - see below.

Ovation Stacking Width

Width	up to 84"	up to 96"	up to 108"	up to 120"
Stack	6½"	7¼"	8"	8¾"

Minimum Ovation Stack

Ovation's fabric stack measures 6½" regardless of the ordered width. Fabric stacking dimensions are determined by the slider's hardware, not ordered width.

Things to Consider

- Since most Ovations are sold in large sizes, the shade will have a large fabric stack. On an outside mount, you may want to order the shade a few inches wider so that the fabric stack can be clear of the window.

Ordering Information for Ovation Cellular Sliders

- Specify IB or OB mount.
- Specify stacking configuration.
On Split Stack Shades, both panels will be of equal width unless specified.
- Specify valance width and return length.

Ovation Valance Specifications

- Every Ovation Slider is supplied with a painted aluminum valance.
- The valance attaches to the head rail using a durable plastic clip system.

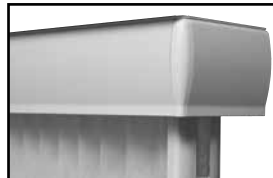

Ovation Valance Dimensions

All valance dimensions are measured on the flat, back side.

- Valance Height: 2¾"
- Standard Return Length (OB only): 3⅛"
- For each spacer block, ½" will be added to the length of the valance returns. For extension brackets, 2" will be added unless otherwise instructed.

Vertical Stacking Options

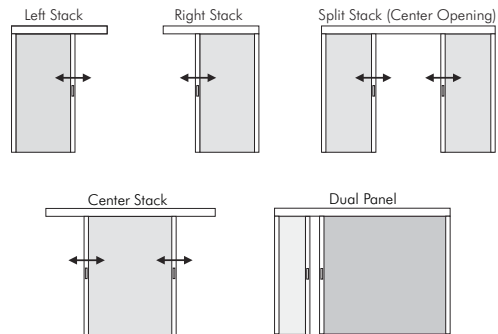

Specify stacking configuration when ordering.

Left: Fabric stacks to the left side of the slider.

Right: Fabric stacks to the right side of the slider.

Center Stack: Center Stack Sliders fabric panels can move fully to the left or the right.

Split Stack: Fabric is split in the center of the slider forming two equal panels which open to opposite ends of the slider. Both panels will be of equal width unless otherwise specified.



PRELUDE HARDWARE

Prelude Cellular STARBURST ARCHES HARDWARE SYSTEM

Stationary Starburst

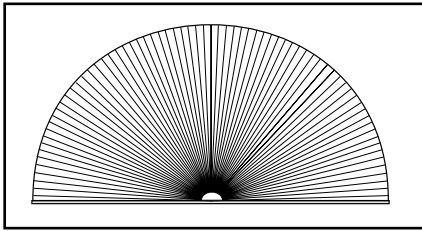

Figure A

Movable Starburst

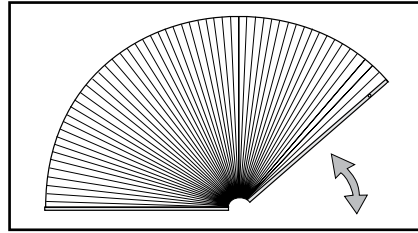

Figure B

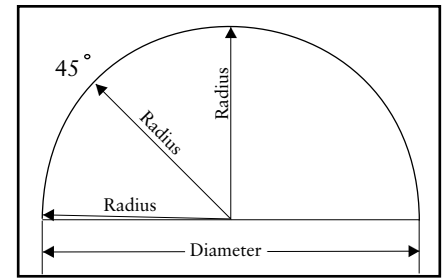

Figure C

Hardware Features	
Standard Hardware colors for Comfortex Prelude	Color coordinated rails
Mounting Dimensions	
Minimum Shallow Mount	3/4"
Minimum Flush Inside Mount	2 3/8"
Recommended Side Mounting Method	• Width limit for side mount brackets is 48"
Finished Dimensions	
Inside and Side Mount	
<ul style="list-style-type: none"> Fabric will measure ordered width less: 3/8" Head rail* will measure ordered width less: 3/16" 	<ul style="list-style-type: none"> * Head rail measurements include endcaps. Width and length measurements may vary +/- 1/8"

Applications

- Stationary Fan Style Arch
 - Movable Fan Style Arch
- Movable Starburst Arch shades are for inside and shallow mount applications only.

Stationary Starburst Features (Figure A)

- All non-perfect Stationary Starburst arches require a template.** See page 119 for template instructions.
- All templates should be made from brown craft paper.** Comfortex offers template kits. Please contact Customer Service to order. Stock number: 751000
- A perfect arch is twice as wide as it is high.
- Stationary Starburst shades which are not perfect half circles must have a height that equals half the width +/- 5".
- Price according to the largest radius measurement. If the height is greater than the width, take height X 2 and use that number to determine pricing.
- When ordering arches as perfect half-circles make sure the radius of the arch remains constant to ensure a proper fit. (See Figure C)

Movable Starburst Features (Figure B)

- Starburst Movable archtop shades are cut to perfect half circles only and do not require a template. The height must be exactly 1/2 the diameter.
- A perfect arch is twice as wide as it is high.
- When ordering arches as perfect half circles make sure the radius of the arch remains constant to ensure a proper fit. (See Figure C)
- The hinge gap (gap between the two rails) is not centered in the window. The moving rail is always smaller than the stationary rail to provide proper movement within the window.

Ordering Information for Sunset Shades

- Specify IB mount and rail color.
- Include a template if the shade is a non-perfect arch.

Accessories

- 6' Expandable Pole



Specially designed pole end fits into the handle on movable Starburst Shades for easy operation.

PRELUDE HARDWARE

Prelude Cellular SUNSET ARCHES HARDWARE SYSTEM

Movable Sunset

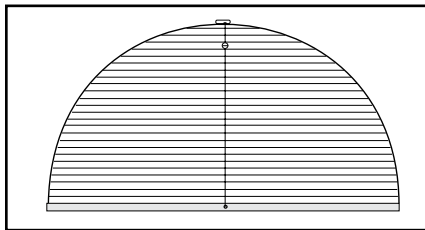

Figure A

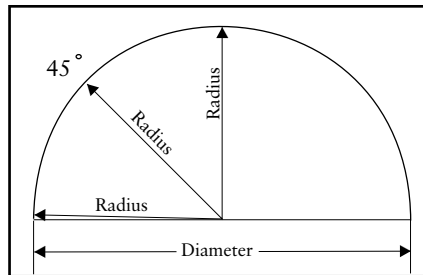

Figure B

Two-String Hanging Method

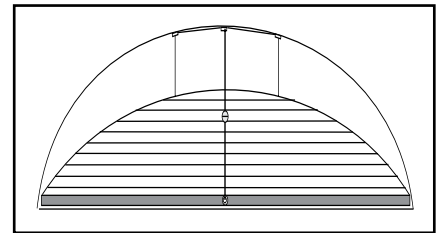

Figure C

Hardware Features | See Page 85 for Rail Dimensions

Hardware colors for all Prelude	Color coordinated head, middle and bottom rails with white cord and silver tassel
---------------------------------	---

Mounting Dimensions	Standard Rail
Minimum Shallow Mount	3/4"
Minimum Flush Inside Mount	2 3/8"
Minimum Side Mount	1 3/8"
Minimum Flush Side Mount	1 7/8"
Recommended Side Mounting Method	<ul style="list-style-type: none"> • See page 68 for recommended mounting method for side mount shades • Width limit for side mount brackets is 48"

Finished Dimensions

Inside and Side Mount	
	<ul style="list-style-type: none"> • Fabric will measure ordered width less: 3/8" • Head rail* will measure ordered width less: 3/16"
Outside Mount	
	<ul style="list-style-type: none"> • Is not offered for Prelude Sunset Top-Down Arches
* Head rail measurements include endcaps. Width and length measurements may vary +/- 1/8"	

PRELUDE HARDWARE

Applications

- Movable Arch

Ordering Information for Sunset Shades

- Include a template if the shade is a non-perfect arch.

Accessories

- 6' Expandable Pole



Specially designed pole end fits into the ball on Sunset Shades for easy operation.

Prelude Cellular SUNSET ARCHES HARDWARE SYSTEM

Sunset Features and Ordering Notes (Figure A)

- Sunset shades have horizontal pleats that stack at the bottom, on a stationary sill rail. Sunset shades are operated by a continuous cord that runs through a top mount guide block and back down through the stationary rail. A moving metal ball attached to the cord is used to raise and lower the shade. (See Figure D).
- **All Sunset arches require a template.** A perfect arch is twice as wide as it is high. See page 119 for template instructions.
- **All templates should be made from brown craft paper.** Comfortex offers template kits. Please contact Customer Service to order. Stock number: 751000
- Sunset shades which are not perfect half circles must have a height which is equal to or greater than 25% of the width.
- When ordering Sunset shades that are perfect half circles, make sure the radius of the arch remains constant to ensure a proper fit. (See Figure B).
- **Stringing Method:** Depending on the curvature of a particular arch, it may be necessary to use the two string method (See Figure C) to ensure proper fit and operation of your Sunset shade. Comfortex will determine the best stringing method after examination of the template.

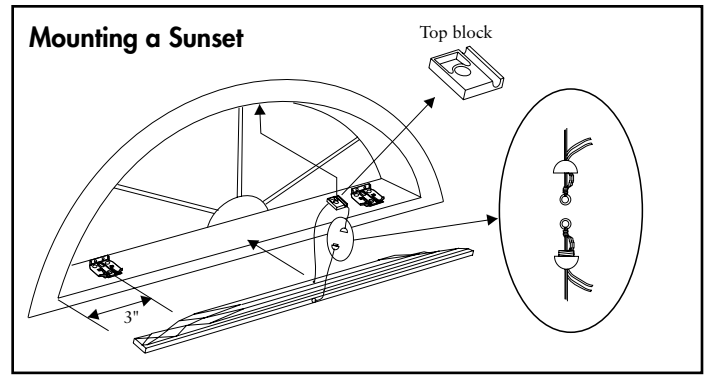

Figure D

Recommended Mounting Method for Side Mounting Shades

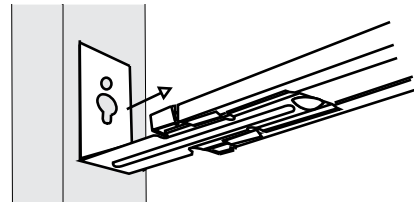

Figure F

Refer to the installation instructions on Comfortexdealers.com or the OnDemand Mobile Library for further details on side mounting shades.

PRELUDE HARDWARE



Prelude Cellular QUARTER ROUNDS HARDWARE SYSTEM

Stationary Quarter Round

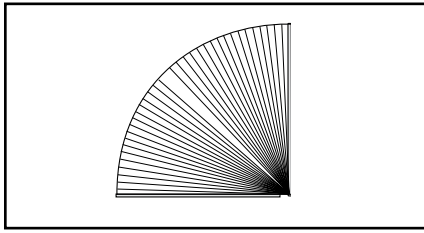

Figure A

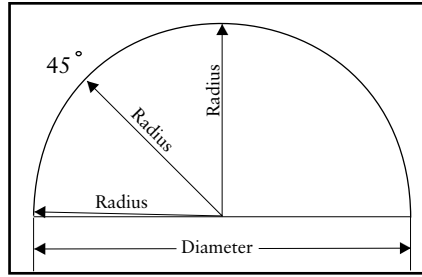

Figure B

Hardware Features	
Hardware colors for all Cellular and Pleated fabrics	Color coordinated rails
Mounting Dimensions	
Minimum Shallow Mount	3/4"
Minimum Flush Inside Mount	2 3/8"
Minimum Outside Mount	3/4"
Minimum Side Mount	1 3/8"
Minimum Flush Side Mount	1 7/8"
Recommended Side Mounting Method	<ul style="list-style-type: none"> • See page 68 for recommended mounting method for side mount shades • Width limit for side mount brackets is 48"
Finished Dimensions	
Inside and Side Mount	
	<ul style="list-style-type: none"> • Fabric will measure ordered width less: 3/8" • Head rail* will measure ordered width less: 3/16"
Outside Mount	
	<ul style="list-style-type: none"> • Fabric will measure ordered width • Head rail* will measure ordered width plus: 3/16"
Exact (End Cap to End Cap) Mount	
	<ul style="list-style-type: none"> • Fabric will measure ordered width less: 3/16" • Head rail* will measure ordered width
* Head rail measurements include endcaps. Width and length measurements may vary +/- 1/8"	

PRELUDE HARDWARE

Applications

- Stationary Fan Style Quarter Round

Ordering Information for Quarter Rounds Shades

- Specify IB or OB mount and rail color.

Quarter Rounds Features

- Price according to the largest radius measurement.
- **All templates should be made from brown craft paper.** Comfortex offers template kits. Please contact Customer Service to order. Stock number: 751000
- When ordering arches as perfect quarter circles, make sure the radius of the arch remains constant to ensure a proper fit. (See Figure B)

Prelude Cellular TRAPEZOIDS AND OCTAGONS HARDWARE SYSTEM

Movable Trapezoids

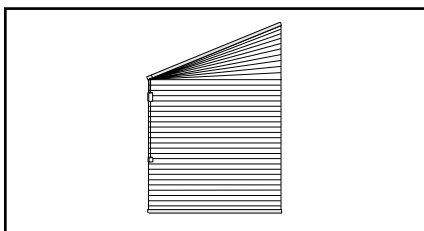

Movable Octagons

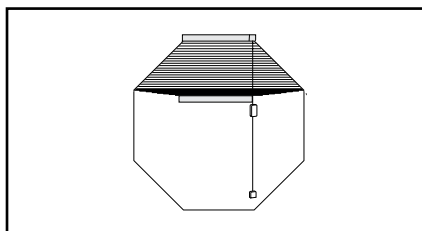

Hardware Features | See Page 85 for Rail Dimensions

Standard Hardware colors for Comfortex Prelude

Color coordinated head and bottom rails with white cord and tassel

Mounting Dimensions

Standard Rail

Minimum Shallow Mount

$\frac{3}{4}''$

Minimum Flush Inside Mount

$2\frac{3}{8}''$

Minimum Outside Mount

$\frac{3}{4}''$

Minimum Side Mount

$1\frac{3}{8}''$

Minimum Flush Side Mount

$1\frac{7}{8}''$

Recommended Side Mounting Method

- See page 68 for recommended mounting method for side mount shades
- Width limit for side mount brackets is 48"

Finished Dimensions

Inside and Side Mount

- Fabric will measure ordered width less: $\frac{3}{8}''$
- Head rail* will measure ordered width less: $\frac{3}{16}''$

Outside Mount

- Fabric will measure ordered width
- Head rail* will measure ordered width plus: $\frac{3}{16}''$

Exact (End Cap to End Cap) Mount

- Fabric will measure ordered width less: $\frac{3}{16}''$
- Head rail* will measure ordered width

* Head rail measurements include endcaps.

Width and length measurements may vary +/- $\frac{1}{8}''$

Applications

- Movable Trapezoids
- Movable Octagons

Ordering Information for Trapezoid Shades

- Specify IB or OB mount and rail color.
- **Trapezoid orders must be faxed in with a diagram. Please provide measurements for all four sides when ordering.**

Ordering Information for Octagon Shades

- Specify IB or OB mount and rail color.
- **The width, length and one side are required measurements when ordering.**

PRELUDE HARDWARE

Prelude Cellular TRAPEZOIDS AND OCTAGONS HARDWARE SYSTEM

Trapezoids (Figure A)

- Trapezoid orders must be faxed in with a diagram. Please provide measurements for all four sides when ordering. Template is required.
- The maximum slope of the top rail is 30 degrees from horizontal. Slope is the angle between slope and a horizontal line. The slope angle must be measured with a protractor.
- Sides of trapezoid must be parallel.
- Sill must be level for proper installation and operation of a trapezoid shade.
- Operating cord must be placed on the short side.
- See Figure B for trapezoid shade operation.

Octagons

- The width, length and one side are required measurements when ordering.
- Octagon shades raise only to the point where the top angle begins. (See Figure C)

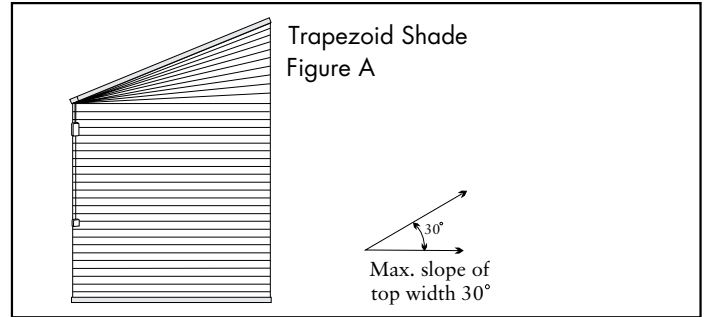

Trapezoid Shade Operation

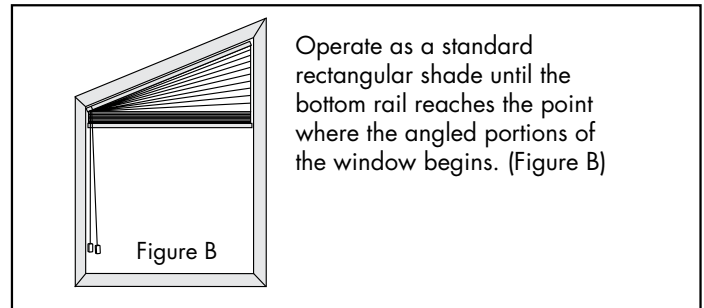

Octagon Operation

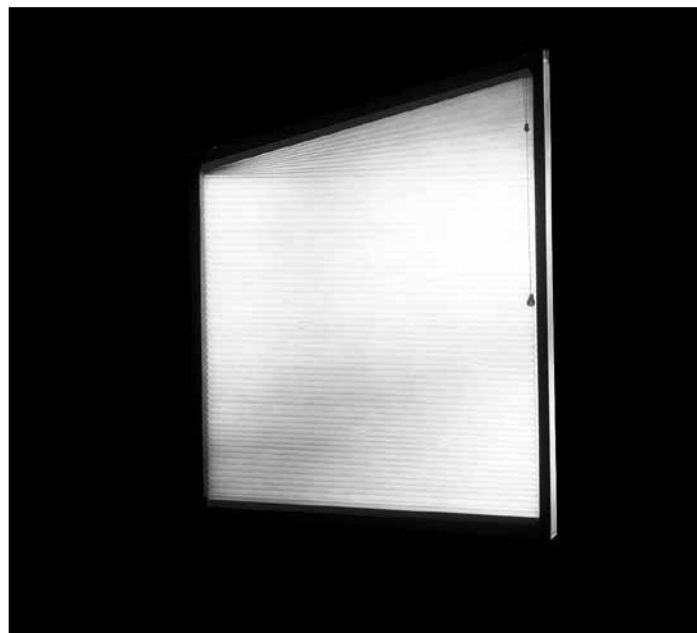
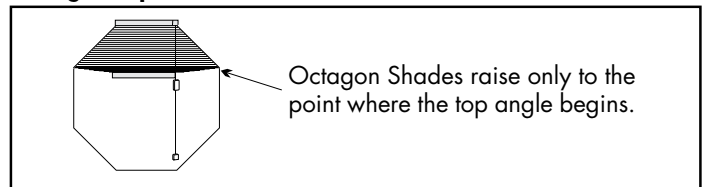

Prelude Cellular SKYLIGHT SHADING HARDWARE SYSTEM

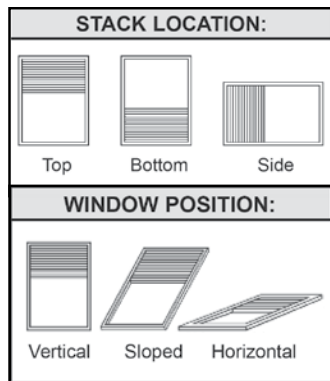
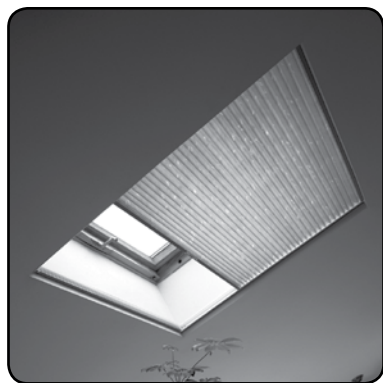

Skylight Vertical Applications

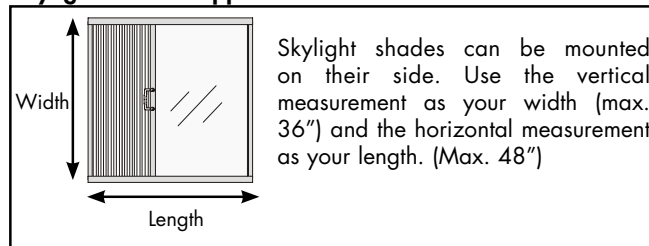

Skylight shades can be mounted on their side. Use the vertical measurement as your width (max. 36") and the horizontal measurement as your length. (Max. 48")

Figure A

Hardware Features	
Standard Hardware colors for Comfortex Prelude	White head and bottom rails with white cord in a white sidetrack.
Upgrades	
Fabric Wrapped Upgrade	Not Available
Designer Metallic Upgrade	Not Available
Mounting Dimensions - Inside Only	
Skylight Shading System	
Minimum required for installation	1 1/4"
Minimum Flush Inside Mount (Rail Fully Recessed)	2 1/2"
The widest width of the window cannot exceed the narrowest width of the window by more than 3/8".	
Finished Dimensions	
Inside Mount	
	<ul style="list-style-type: none"> Fabric will measure ordered width less: 3/4" Head rail* will measure ordered width less: 3/16"
* Head rail measurements include endcaps. Width and length measurements may vary +/- 1/8"	

Applications

- Horizontal, Angled and Vertical rectangular windows and skylights. Skylight Shading Systems are for inside mount applications only.

Ordering Information for Skylight Shading System

- Specify when ordering: Application angle: Angled, Horizontal or Vertical.

Accessories

- 6' Expandable Pole



Specially designed pole end fits into the handle of Skylight shades for easy operation at any angle.

Skylight Shading System Features

- Shades can be mounted on their side. (See Figure A). Use the vertical measurement as your width (max. 36") and the horizontal measurement as your length (max. 48").
- Track system provides superior insulation and light blocking. The enclosed sides provide full privacy.
- Shades over 30" wide require support cords.
- Fabric gasket attached to moving rail to eliminate light leakage when shade is closed.

PRELUDE HARDWARE

Cellular Shade Collection
HIGHLIGHTS CORNICE VALANCE

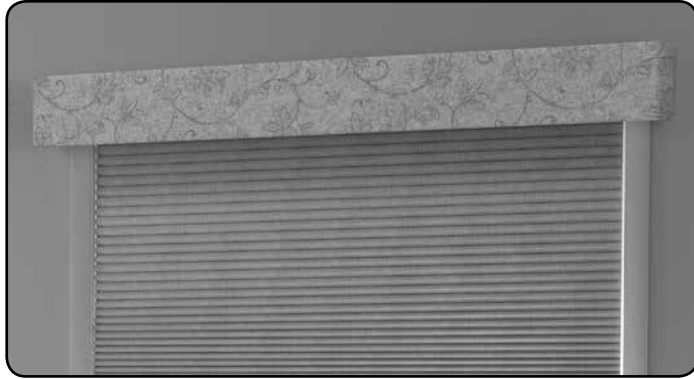

Highlights Cornice Valances

Elevate your windows to a whole new level of design with the Highlights Cornice Valance. Coordinate with other design elements in your room. Add a finishing touch to the top of any window treatment.

The Highlights Cornice Valance is versatile and beautiful at a price point that won't leave you wondering how to cover the rest of your windows!

Choose from any fabric in our Envision™ line and customize the valance with our 7 available return sizes to best fit your application.

Easy assembly and quick installation, with the Highlights Cornice Valance, more beautiful windows are within your reach.

Refer to your Envision price list for pricing and specifications.

Cut-Outs

Cut-outs are available with all cellular fabrics and are subject to approval by the Comfortex Technical Service department.

There are no limits on cut out lengths. There are limits on cut out widths:

- Cellular shade widths 18" or less 3" maximum width
- Cellular shade widths greater than 18" 5" maximum width

Odysee Cellular Blinds



HARDWARE OPTIONS

Odysee Cellular Blinds Features at a Glance

- Odysee Insulating Blinds provide the same energy saving benefits as classic cellular shades, but with the enhanced versatility of fully functional vanes.
- The Odysee vanes expand and compress to create several innovative views. Expanded vanes offer complete privacy, energy efficiency and hidden lift cords. Compressed vanes provide variable light control and substantial view through -like a wood blind.
- All Odysee Blinds are built with a PowerTouch™ system as standard.
- Odysee vanes are available with light filtering or room darkening fabric.
- Odysee provides the convenient operation of a blind with soft fabric look of a shade.
- All Odysee vanes are white to the outside for a uniform exterior appearance.
- A limited lifetime warranty serves as a commitment to your satisfaction.



Odysee Cellular Blinds Hardware Options

	Key Features	Color Options	Hardware Size (Depth x Height)	Shade Size Available	More Information
<p>PowerTouch™ Cordless Motorized Wand</p> 	<ul style="list-style-type: none"> • Child safe • NiMH Rechargeable Battery Wand • Standard on shades up to 72" x 84" 	<ul style="list-style-type: none"> • White Head & Bottom Rails • Color matched fabric head rail insert strip 	<p>Head Rail: 2 5/8" x 2 1/8"</p> <p>Bottom Rail: 1 3/4" x 1/2"</p>	<p>Width: 20" to 72"</p> <p>Length: 12" to 84"</p>	Page 112
<p>Cord Loop</p> 	<ul style="list-style-type: none"> • Integrated clutch locking system • Cord Loop makes operation easy • Smooth & quiet operation 	<ul style="list-style-type: none"> • White Head & Bottom Rails • Color matched fabric head rail insert strip 	<p>Head Rail: 2 5/8" x 2 1/8"</p> <p>Bottom Rail: 1 3/4" x 1/2"</p>	<p>Width: 20" to 108"</p> <p>Length: 12" to 120"</p>	Page 111
<p>Simplicity Motorization</p> 	<ul style="list-style-type: none"> • Raise & lower shade with a click of a button • Great for large and hard to reach windows • Remote can operate multiple blinds 	<ul style="list-style-type: none"> • White Head & Bottom Rails • Color matched fabric head rail insert strip 	<p>Head Rail: 2 5/8" x 2 1/8"</p> <p>Bottom Rail: 1 3/4" x 1/2"</p>	<p>Width: 20" to 96"</p> <p>Length: 12" to 96"</p> <p>Maximum Area: 50 Sq. Ft.</p>	Page 113

ODYSEE CELLULAR BLINDS

Odysee Cellular Blinds
PRICING

Separate Discount Applies

PRICE GROUP 40
PowerTouch™ or Cord Loop System -
Light Filtering

		Width In Inches														
		24	30	36	42	48	54	60	66	72	78	84	90	96	102	108
Length In Inches	36	353	397	449	505	557	597	651	706	755	807	858	908	969	1024	1081
	42	381	432	490	557	610	668	725	787	843	902	963	1020	1081	1145	1211
	48	400	465	530	594	659	719	786	847	915	977	1037	1107	1176	1245	1317
	54	422	488	559	632	706	768	840	913	978	1047	1115	1192	1265	1341	1418
	60	460	526	606	678	758	837	911	985	1063	1144	1222	1297	1376	1458	1539
	66	487	562	647	730	817	902	980	1066	1150	1239	1323	1417	1495	1585	1673
	72	509	589	681	783	866	946	1049	1125	1222	1310	1398	1508	1590	1684	1779
	78	543	632	730	832	931	1012	1106	1207	1304	1401	1500	1601	1704	1807	1908
	84	565	668	768	876	980	1070	1171	1277	1382	1493	1593	1696	1804	1912	2021
	90	592	699	814	919	1036	1130	1243	1357	1467	1582	1691	1806	1919	2034	2149
	96	615	730	846	966	1090	1186	1303	1422	1539	1658	1778	1899	2021	2140	2263
	102	706	815	920	1042	1150	1244	1388	1522	1628	1735	1846	2003	2114	2242	2366
108	743	858	970	1095	1209	1308	1457	1599	1713	1833	1941	2092	2205	2339	2471	
114	787	908	1030	1162	1289	1389	1544	1696	1816	1938	2062	2218	2340	2479	2620	
120	843	973	1106	1243	1372	1487	1652	1816	1944	2073	2206	2375	2506	2655	2802	

█ Simplicity Motorized Lift System is not offered within the shaded area.

▭ Sizes up to 72" width by 84" length are built as PowerTouch™ Cordless Motorized Wand unless otherwise specified.

LIFT SYSTEM AND DESIGN UPGRADES			ADD
Solid Colors and Natural Texture Collection Fabrics	Light Filtering		Grid 40
	Room Darkening		10% to Grid 40
Personal Color System Fabrics	Light Filtering		10% to Grid 40
	Room Darkening		10% to Grid 40 PLUS 10%
Cord Loop Option		Pg 111	FREE
MOTORIZATION			MORE INFO
			ADD
Custom PowerTouch Wand length		Pg 113	\$32
Simplicity - Motor and Battery Wand, Standard or Rechargeable (excludes remote)		Pg 113	\$405
Simplicity 5 Channel Remote		Pg 112	\$41
Simplicity 6 Channel Remote with Timer		Pg 113	\$67
Simplicity 14 Channel White Remote		Pg 58	\$67
DC Power Supply/Transformer		Pg 113	\$36
14 Volt Charger for NiMH Rechargeable Motor		Pg 114	\$36

Odysee Cellular Blind Motorized Pricing Examples

PowerTouch Pricing Example:

Light Filtering 42" x 60" Shade:	\$678.00
Custom Wand Surcharge:	\$32.00
Power Supply/Transformer:	\$36.00
Total List Price:	\$746.00

Rechargeable Simplicity Pricing Example:

Light Filtering 42" x 60" Shade:	\$678.00
Simplicity Rechargeable Motor Surcharge:	\$405.00
Charger for Rechargeable:	\$36.00
Simplicity Remote Control:	\$41.00
Total List Price:	\$1160.00

Odysee Cellular Blinds
HARDWARE SYSTEM

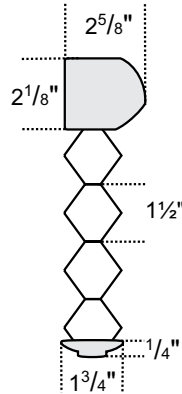
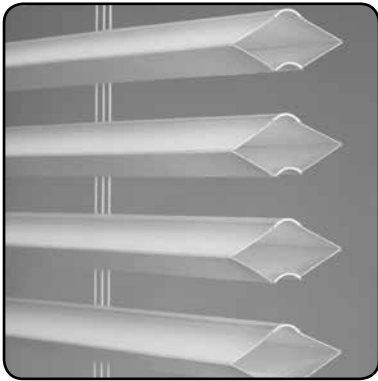

Odysee Cellular Blind Rail Dimensions

- Depth of head rail: 2⁵/₈"
- Height of head rail: 2¹/₈"
- Height of cell: 1¹/₂"
- Depth of bottom rail: 1³/₄"
- Height of bottom rail: 1/4"

Hardware Features	
Hardware colors for all Odysee Cellular Blinds	<ul style="list-style-type: none"> • White head rail and bottom rail. The head rail includes a color matched fabric head rail insert strip. • PowerTouch Wand is white • Operating cord and cord tensioner are white. • There may be a gap from the head rail to the top vane (when the vanes are fully expanded) could be up to 3/16". The lip on the back of the head rail will prevent "view through" to the outside.

Mounting Dimensions	Odysee Cellular Blind Hardware System
Inside Mount	
Minimum Shallow Mount	1 1/4"
Minimum Flush Inside Mount	2 7/8"
Minimum Rear Vane Clearance	1/8"
Outside Mount	
Minimum Shallow Mount	1"
Minimum Flush Inside Mount	2"
Minimum Outside Mount	1/8"
Side Mount	
Minimum Shallow Mount	1 1/2"
Minimum Flush Inside Mount	2 5/8"
Minimum Outside Mount	1/8"

Finished Dimensions	Odysee Cellular Blind Hardware System
Inside Mount	
	<ul style="list-style-type: none"> • Head rail* unit ordered width less: 3/16" • Blind length up to 1 5/8" more than ordered length; bottom vane may not fully extend when blind is fully lowered • Fabric width ordered width less 1/2"
Outside Mount	
	<ul style="list-style-type: none"> • Head rail* unit ordered width plus: 3/8" • Blind length up to 1 5/8" more than ordered length • Fabric width ordered width

* Head rail measurements include endcaps. Width and length measurements may vary +/- 1/8"

ODYSEE CELLULAR BLINDS

Odysee Cellular Blinds HARDWARE SYSTEM

Applications

- Standard Rectangular
- PowerTouch™ Rechargeable is standard for shades up to 72" x 84"

Fabric Collections

You can select fabrics from two collections:

- **Standard and Natural Textures Collection:** Solid and patterned light filtering and room darkening colors.

Operating Cords (Optional)

- The cord loop is made of white nylon.
- Standard cord placement is right. Please specify location when ordering.
- Cord Loop System cords come in 2 foot to 15 foot lengths in 1 foot intervals. Please specify length when ordering.

Standard loop sizes are as follows:

Blind Length	Standard Loop
Up to 36"	2' (24")
36" to 60"	3' (36")
60" to 84"	4' (48")
84" to 108"	5' (60")
108" to 120"	6' (72")

Vane Stack

Odysee Blinds are designed for both function and aesthetics with the opening and closing of the vanes, providing a view-through to the outside. While an Odysee Blind can be raised and lowered, a raised blind may result in a wavy stack resulting from the accumulation of aluminum lifters located on the cords. The aluminum lifters allow the vanes to be opened and closed



Stack Height

All measurements include head and bottom rails.

Blind Length	Stacking Height
Up to 12"	3¼"
12½" to 24"	4¼"
24½" to 36"	5¼"
36½" to 48"	6¼"
48½" to 60"	7¼"
60½" to 72"	8¼"
72½" to 84"	9¼"
84½" to 96"	10¼"
96½" to 108"	11¼"
108½" to 120"	12¼"

Odysee Vane Characteristics

What size is a vane?

A vane is 1" high.

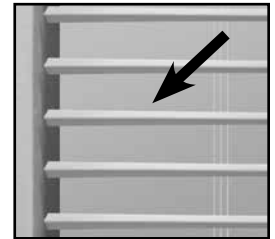

Vane Flare

A certain level of flare is common on the sides of the vane. This characteristic is designed into the blind to assist in closure when the vanes are fully expanded.

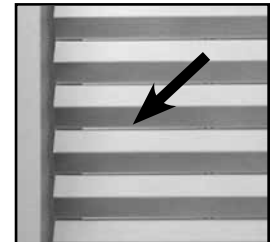

Vane Gap

It is not uncommon to have very small gaps between the vanes; however, the gaps should not be large enough for you to "view through" to the outside.

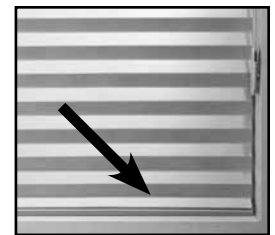

Bottom Vane

The bottom vane is designed to stay flat and may appear extra. In addition, some blinds may need an extra vane in order for the blind to reach the bottom sill. When the vanes are expanded, the extra vane may be partially compressed because of the size of the window.

What do I do if an expanded vane is pushed in?

If the vane is pushed in, do not raise the blind. Carefully push the vane out with your finger or the eraser end of a pencil.

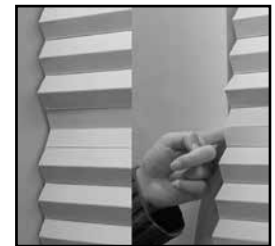

What do I do if the vanes do not expand or compress uniformly?

If one or more vanes hang up when opening or closing the blind, you can reset the vanes by toggling the cord loop back and forth.

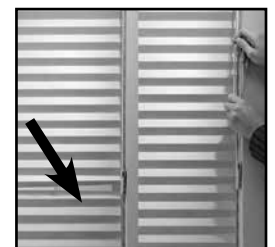

Are there color differences between Light Filtering and Room Darkening Vanes?

Due to the differences between the light filtering and room darkening base material, slight color variations may exist. These slight color variations are within established industry standards and should be expected.

Odysee Cellular Blinds

CORDLESS POWERTOUCH HARDWARE SYSTEM

Cordless PowerTouch Push Button Control Applications

- Standard Rectangular
- PowerTouch™ Rechargeable is standard for shades up to 72" x 84"

Odysee Cellular Blinds can be fabricated with the Cordless PowerTouch Push Button Control option.

The PowerTouch option is an easy, cord free motorized operation for the budget savvy homeowner. PowerTouch uses Simplicity motors and components.

PowerTouch Operation

Press and hold the up or down button on the pendant to adjust the blind position. Release the button to stop the blind at your desired position. No programming is required.

The PowerTouch system is most convenient for adjusting the vanes between open and closed; but can also be used to raise and lower the blind.

All fabrics will use white wand and pendants.
All standard Odysee discounts apply to PowerTouch Blinds.

PowerTouch Appearance

- The PowerTouch wand and pendant is attached to the head rail and requires no additional mounting.
- The wand and pendant hangs down the front of the blinds from the head rail. The wand does not touch the fabric.
- Pendant is 2½" long.
- The pendant does not need to be mounted to the wall to operate the blind.

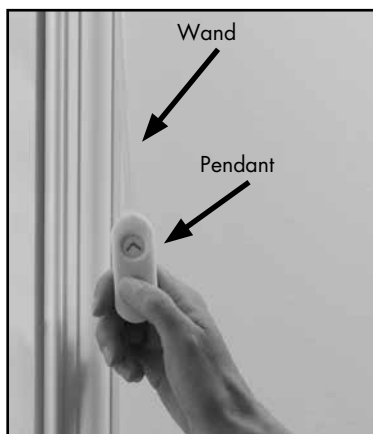

PowerTouch Rechargeable NiMH Battery Wand is Standard

Please see page 113 for more information.

PowerTouch Color Options

- All Odysee Blinds will use white wand and pendants.

PowerTouch Wand Length

- The standard length of the wand will measure half the ordered length of the blind.
- Maximum wand length is 56" including the pendant.
- Custom wand lengths are available in 1" increments up to 56", specify when ordering. Custom wand length surcharge applies.

PowerTouch Wand and Pendant Location

The standard location for the wand and pendant is on the right. Please specify location when ordering.

Mounting Requirements for Odysee Cordless PowerTouch Blinds

- No special installation hardware or wiring requirements are needed to install Odysee Cordless PowerTouch Blinds.
- The wand and pendant do not need to be mounted to operate the blind.

Cordless PowerTouch Blinds Reloadable Battery Wand (Optional)

The battery wand is wall or ceiling mounted utilizing white battery wand clips. The 12 volt battery wand measures 17¼", and comes with eight alkaline batteries, and is white in color.

The battery wire is 10" long. A 48" extension wire is available.



PowerTouch Wand Battery Life and Replacement

Eight alkaline batteries are included with the battery wand. The battery life will vary based on the type of window covering selected, the size and weight of the window covering and the number of times you operate the blind on a daily basis.

Comfortex will warranty batteries for up to 3 months from date of purchase.

DC Power Supply/Transformer

12 Volt DC power supply/transformer is available and requires a standard power outlet to power the motor. The transformer is an alternative to a battery wand. Each transformer can power a single blind. The power supply must plug in to the motor. The DC power supply is white and comes with a 80" wire. The dimensions are 1⅞" wide x 3¼" long x 1¼" deep.

Odysee Cordless PowerTouch Blinds Warranty

Please see page 122 for complete warranty information.

Odysee Cellular Blinds

RECHARGEABLE SIMPLICITY MOTORIZED HARDWARE SYSTEM

Motorized Odysee Cellular Blinds

Odysee Cellular Blinds can be motorized with Simplicity Radio Controlled Motors.

Rechargeable Simplicity Motors

The Simplicity Motor program features a battery powered motor utilizing a rechargeable battery wand. Simplicity motors are compact and use a radio controlled remote to raise or lower the shades.

Rechargeable Motorized Lift Systems are not offered on sizes within the shaded area on the Standard Rectangular price grids.

Applications

- Standard Rectangular

Mounting Requirements For Motorized Odysee Cellular Blinds

No special installation hardware or wiring requirements are needed to install motorized Odysee Blinds. See page 110 for mounting information.

Simplicity Rechargeable Battery Wand

The wand will be concealed in the head rail on shades over 28" wide. The battery wand measures 22", comes with NiMH rechargeable batteries, and is white in color. For blinds less than 28" wide, the rechargeable battery wand can be clipped to the wall or ceiling mounted utilizing supplied battery wand clips.

Rechargeable battery wand comes fully charged from the factory.



Rechargeable Battery Wand Concealed in Head rail.
(Minimum width of 28" required)

Simplicity Motor Hand Held Remotes 5 Channel Remote

The **5 Channel (5C) remote** can operate up to five shades individually or in groups. **WHEN ORDERING PLEASE SPECIFY WHICH CHANNELS ARE ASSIGNED TO EACH SHADING OR GROUP OF Shades.**

For example; program line 1 to channel 1, line 2 and 3 to channel 2, etc. If no channels are assigned at time of order, all shades will be programmed to Channel 1.



Simplicity 5C remotes and holders are white or black in color. The remote comes with a holder which can be mounted to a wall for easy storage. The range of the remote is approximately 80 feet.

6 Channel Timer Remote

The **6 Channel (6C) timer remote** combines the functionality of a fifteen channel hand-held control with the convenience of a programmable timer.

- The 6C timer remote allows for 18 different scheduled actions each day of the week.
- Manual function disables the timer and the remote then operates as a 1-channel hand held remote.



WHEN ORDERING PLEASE SPECIFY WHICH CHANNELS ARE ASSIGNED TO EACH SHADING OR GROUP OF SHADES.

For example; program line 1 to channel 1, line 2 and 3 to channel 2, etc. If no channels are assigned at time of order, all shades will be programmed to Channel 1.

Simplicity timer remotes and holders come in white. The remote comes with a holder which can be mounted to a wall for easy storage. The range of the remote is approximately 80 feet.

14 Channel White Remote also available (page 56)

DC Power Supply/Transformer

12 Volt DC power supply/transformer is available and requires a standard power outlet to power the motor. The transformer is an alternative to a battery wand. Each transformer can power a single shading. The power supply must plug in to the motor. The DC power supply is white and comes with a 80" wire. The dimensions are 1 7/8" wide x 3 1/4" long x 1 1/4" deep



Odysee Cellular Blinds

RECHARGEABLE SIMPLICITY MOTORIZED HARDWARE SYSTEM

Battery Charger

14 Volt charger requires a standard power outlet to recharge the battery wand. Must specify charger when ordering a Simplicity Rechargeable Wand Shade. The charger plugs into the charger port. The charger is black and comes with a 156" wire. The dimensions are 1 7/8" wide x 3 1/4" length x 1 3/4" deep.

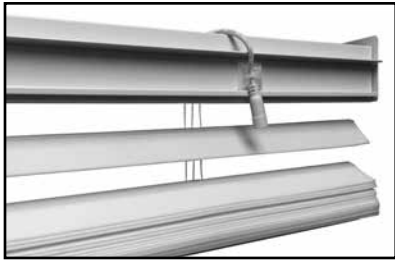

Charging Port on Back of Head rail



Simplicity Rechargeable Battery Life

Rechargeable batteries are included with the motor.

The average battery charge will last 6-12 months based on an average sized shade opened and closed once per day. The life of a single charge will vary based on the type of window covering selected, the size and weight of the window covering and the number of times the cellular blind is operated on a daily basis.

The battery can be recharged up to 500 times. It takes approximately 5 hours to recharge the motor when fully depleted.

Retrofit Existing Standard Simplicity Motorized Shades with Rechargeable Batteries

Cellular shades made with Standard Simplicity Motorization can be retrofitted with the Rechargeable Simplicity Motorization Battery Wand. The Rechargeable battery wand is 22" long, comes with 10 NiMH batteries, and is white in color. Battery wands are charged at the factory.

Retrofit Ordering Requirements:

- Rechargeable battery wand with clips (one per shade)
- Rechargeable battery charger (one or more per order, or as needed)
- Charge port mounting base (optional)

Please contact customer service for more information.



Odysee Cellular Blinds

GENERAL INFORMATION

Operating Cord Loop Odysee Blinds

- A single cord loop and clutch combination is used to raise and lower the blinds, as well as open and close the vanes.
- To compress the vanes or lower the blind, pull on the rear of the cord loop. To expand the vanes or raise the blind, pull on the front of the cord loop.

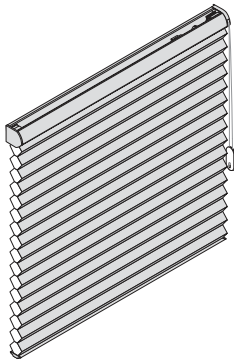

Privacy Position
(Vanes expanded)

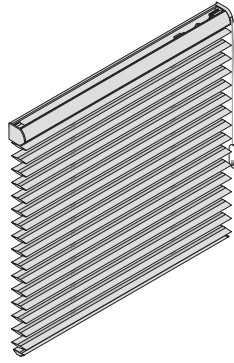

View-Through Position
(Vanes compressed)

If at any time the vanes do not expand or compress uniformly you can reset the vanes by toggling the cord loop. Opening and closing the vanes should re-align them with uniform expansion or compression.

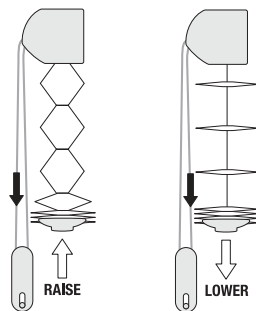

Bottom Rail

Odysee Cellular Blinds feature a creamy white bottom rail.

When the vanes are expanded (closed), the bottom rail touches the window sill. When the vanes are compressed (open), the bottom rail may lift off the sill slightly. This is normal.

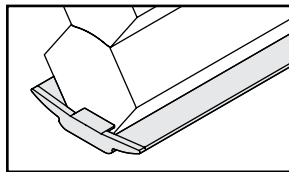

Odysee Certified Fabrics

The GREENGUARD Environmental Institute has established performance based standards to define goods with low chemical and particle emissions for use indoors.

Odysee fabrics have earned the following certifications:

- GREENGUARD Indoor Air Quality Certified® certification for low emitting interior building materials, furnishings, and finish systems.
- GREENGUARD Children & SchoolsSM product certification for low emitting interior building materials, furnishings, and finish systems used in educational (day care and K-12) environments.

Cellular Shade Collection
GENERAL INFORMATION

CELLULAR GENERAL INFORMATION

Scotchgard™ and Certified Fabrics

Scotchgard Protection

Scotchgard™ Protector is available with all cellular Shades. Scotchgard™ keeps your shades looking newer, fresher and cleaner longer.



A combination of the latest advances in stain release and repellency provides exceptional stain protection. Spills wipe away easily and most dirt and stains lift out when cleaned. Both sides of the fabric are treated with Scotchgard.

GREENGUARD Certified Fabrics

GREENGUARD Indoor Air Quality Certified® Fabrics
 The GREENGUARD Environmental Institute has established performance based standards to define goods with low chemical and particle emissions for use indoors.

The following fabrics have the passed GREENGUARD Indoor Air Quality Certified® certification program for low emitting interior building materials, furnishings, and finish systems:

- Symphony (All)
- Virtuoso (All)
- Baritone (All)
- Premiere (All)
- Natural Linen Flax
- Debut (All)
- Linen Weave

The following fabrics have the passed GREENGUARD Children & Schools™ product certification program for low emitting interior building materials, furnishings, and finish systems used in educational (day care and K-12) environments:

- Symphony Light Filtering
- Symphony Blackout

Symphony Flame Resistant Fabrics

Symphony Flame Resistant Fabrics have been registered as a Flame Resistant Products by the California State Fire Marshall for products identified in section 13115, California Health and Safety Code (California CHSC). Copies of the certificates are located on the Comfortex.com/comfortex-dealers web site or on the On Demand Mobile library.

Color Selection

Use the current Cellular Shades Collection sample book to select colors from the Symphony light filtering fabric collection. All thirty colors are available in 3/8" Symphony light filtering double cell and 3/4" light filtering single cell.

Ordering Flame Resistant Shades

The SKU structure for Symphony Flame Resistant material is: 3012 05 XXX (XXX representing the color number).

To order Symphony Flame Resistant Shades: Use the SKU number listed on the decks.

The SKU structure for the 3/4" Symphony Flame Resistant material is: 2512 05 XXX

To order 3/4" Symphony Flame Resistant Shades:

Use the Symphony three digit color number to identify your desired color.

In this example:
 2512 05 108



EZ Level on Comfortex Cellular Shades

EZ Level makes quick work of leveling without cords to cut or tuck into a rail. No special tools needed – just use a nickel, quarter or penny to adjust plug on the bottom rail.

EZ Level is standard on all Cellular and Pleated Shades with the following hardware systems:

- Standard and Deluxe Cord Lock
- Cordless Ultra
- Cord Loop
- SlumberShades
- Simplicity Motorized Systems

EZ Level is not available with Lift & Lock Cordless.

How does EZ Level work?

- Slightly raise the bottom rail you want to level.
- Insert a coin or flat head screwdriver into the adjustment screw and turn it.
- Turn the adjustment screw clockwise or counter clockwise to make slight adjustments up or down.



One quarter turn of the adjustment screw will move the bottom rail up or down 1/4".

- Lower the rail to check the level and make further adjustments if necessary.

Cellular Shade Collection

GENERAL INFORMATION

Cleaning and Care

While beautiful and pleasing to the eye, all Comfortex products are designed to be durable, easily cared for and easily cleaned. Our non-woven fabrics are inherently anti-static and repel dust, but occasional feather dusting or vacuuming may be necessary to keep the fabrics clean and bright. Comfortex Cellular fabrics may be ultrasonically cleaned.

Cleaning Virtuoso Blackout, Baritone Blackout and Symphony Blackout Fabrics: Our blackout fabrics are inherently anti-static and repel dust, but occasional cleaning may be necessary to keep the fabrics clean and bright. The fabric can be dusted with a soft, clean cloth, feather duster or lightly vacuumed with a soft brush attachment. To spot clean, use a cloth or sponge dipped in a light solution of lukewarm water and clear dish detergent and lightly dab. Do not scrub the surface. Rinse thoroughly.

Cleaning all other Comfortex Cellular or Pleated Fabrics:

Our light filtering and room darkening fabrics are inherently anti-static and repel dust, but occasional cleaning may be necessary to keep the fabrics clean and bright. The fabric can be dusted with a soft, clean cloth, feather duster or lightly vacuumed with a soft brush attachment. Spills and stains can be lightly blotted with a cloth or damp sponge. More difficult stains may require soaking in water with mild soap. For this, remove the shades from the window and soak in warm water. Complete immersion of hardware is not recommended.

DO NOT submerge the Cordless Ultra head rail in water. When damp, lay flat to dry or place back in window and raise tightly to recrisp pleats. Please test any stronger cleaners on an unobtrusive portion of the shade before using.

For additional advice on care or cleaning, please contact our Technical Services Department.

Cleaning and Care of Odysee Cellular Blinds

Regular feather dusting or vacuuming will keep Odysee Cellular Blinds looking new for years.

Odysee Cellular Blinds can be spot cleaned. Gently blot the stain with a clean, non-alcohol baby wipe. Instead of a baby wipe, you may use a clean white cloth with a mild cleaning solution. Support the fabric from behind using another clean, dry cloth. Clean the fabric using a gentle blotting action. Do not rub the fabric. Any abrasive action may cause the fabric to pill or distort. Allow the fabric to air dry with vanes expanded.

Forced air can also be used to blow out dirt and debris from within the vanes using clean compressed air or a hair dryer on the COOL setting.

Odysee Cellular Blinds can also be ultrasonically cleaned. Do not immerse the head rail. Comfortex acknowledges these cleaning methods as being safe and effective. We cannot attest to the quality of equipment or services provided by any independent cleaning facility.

Scotchgard™ Treated Shades

The following are the recommended cleaning and care instructions for window treatments with fabric treated with Scotchgard™ Protector.

- Gently blot liquid stains immediately with a clean, white cloth.
- If stain remains, prepare a solution of ¼ teaspoon of clear, non-bleaching dish detergent mixed with 1 cup of lukewarm water. Dampen a clean white cloth and gently blot the stain.
- Do not overwet the fabric or excessively rub the stained area.
- See the Installation and Care instructions for complete details.

For additional assistance with stain removal, call the Scotchgard™ Protector Service Center at 1-800-433-3296. Customer Care representatives are available Monday through Friday, 8am to 6pm CT.

Cellular Shade Collection

GENERAL INFORMATION

Cellular Shade

MEASURING INSTRUCTIONS

Comfortex accepts measurements down to $\frac{1}{16}$ " increments.

Inside Mount

Use a steel tape to measure the opening at three different places, and use the narrowest dimension when ordering. Be exact! The factory will make the shade $\frac{3}{16}$ " narrower so it will not rub against the window casing. Measure the height of the window from the top (soffit) down to the sill.

Outside or Ceiling Mount

Use a steel tape to measure the exact height and width of the area to be covered. It is recommended that the shades overlap the window by at least $1\frac{1}{2}$ " on each side. When installation has no sill, allow the shade to overlap the bottom of the window casing by at least $1\frac{1}{2}$ ". Shade fabric will measure width indicated on the order form.

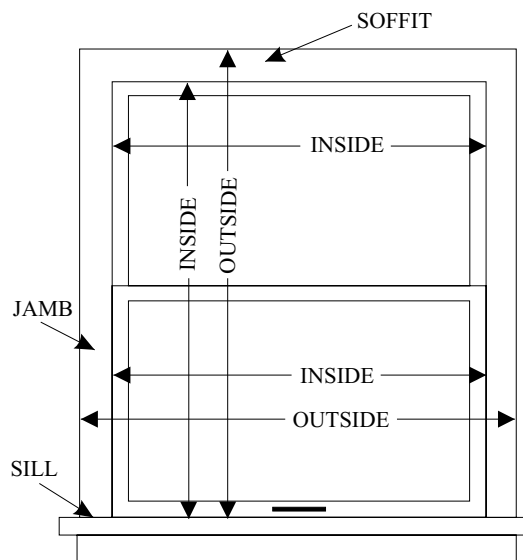

Measuring for Specialty Shapes

Templates are required with some specialty shade orders. Consult the individual product sections of this guide for specifics regarding accurate measurements and mounting information.

Arches and Quarter Round Circles

- Measure the window height and width appropriately for an inside or outside mount.
- With perfect arches, the height will be one half the width. With perfect quarter rounds, height will equal width. If the arch or quarter round is perfect, **a template is not required.**
- Windows with imperfect arch measurements do not maintain the height/width relationship. Templates **are required** for these windows.

Trapezoids

- Measure the window height and width appropriately for an inside or outside mount. For outside mounts, remember to add the desired amount of overlap.
- Measure all four sides for accurate fabrication. Provide all measurements. **Templates are not required.**
- The slope angle must be measured with a protractor. Slope is the angle between slope and a horizontal line. The maximum slope is 30 degrees.

Octagons

- Measure the window height and width appropriately for an inside or outside mount. Be sure to measure the width at the shade's widest point.
- Provide the width, length and the length of one side when ordering.

Cellular Shade Collection

GENERAL INFORMATION

Making the Perfect Template

Tape brown craft paper over the window opening. Be sure to allow plenty of overlap and check to see that the paper is smooth and pulled taut. Do not use newspaper as the ink can rub off on fabric. Do not use paper that has been folded. Notice the outline of the framework superimposed on the template as the light filters through the window. You may create the template in one of two ways:

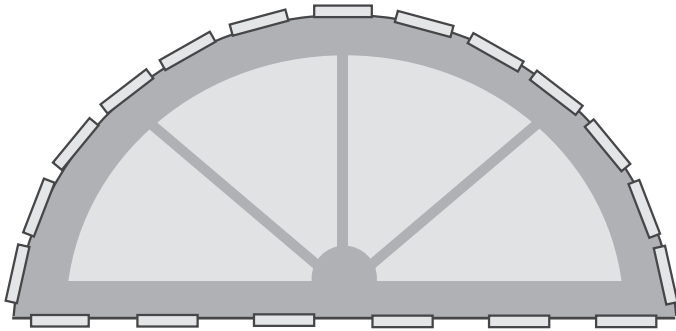

Trace the outline of the window with a pencil and continue along the side of the window frame. Once the window is completely traced, remove the craft paper from the window. Cut out the traced shape with a pair of scissors.

You may choose to skip tracing the window outline with a pencil and cut out the shape immediately with a razor knife.

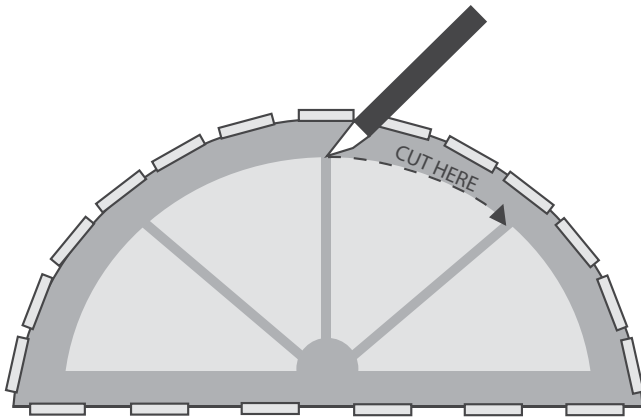

Once your template is cut, double check its width and height with your initial measurements. Test the template by placing it in the window. Check for light gaps, uneven cutting of curves etc. Trim or remake if necessary.

With arch top shades, fold the template in half. Check the outline of the curve for smoothness, light gaps and curve continuity. Place the template in the window and check it for light gaps or uneven cutting of curve. Trim or remake it if necessary.

On the front of the template, mark the shade measurements along with your company name, account number, sidemark, shade style and color. Be sure to indicate inside or outside mount, the room side and which ends of the template are top and bottom. Do not take any deductions on inside mount shades. The factory will make all necessary allowances for inside mounts.

Remember: The quality of the finished shades depends heavily on the quality of the template supplied. Do not hesitate to remake a template if you feel uncomfortable of the quality of your first attempt.

Template Kits: Comfortex offers template kits which includes brown craft paper, razor knife, instructions and order form. Please contact Customer Service or visit www.comfortex.com to order. Stock number: 751000

Cellular Shade Collection
GENERAL INFORMATION

GENERAL INFORMATION

Conditions of Sale

All Comfortex products are custom fabricated to your exact specifications. We cannot accept responsibility for errors in ordering or cancellations and charges after the order is in production.

Policies

Our policies are designed to provide a guide for doing business with Comfortex. Our first priority and number one policy is to provide the highest level of service and total satisfaction.

Freight Policy

Fabricated Shades/Blinds

Comfortex will ship all orders for fabricated shades or blinds freight free via UPS, FedEx Ground or other similar method within the Continental US.

Transportation Surcharge: A \$5.50 per unit transportation surcharge will be added to all fabricated product orders shipping within the Continental US; including shades/blinds, vane packs, individual vanes, tracks, valance and cut yardage orders. Exception: Vertical Sheer Shadings, Ovation Cellular Slider and Envision Panel Track system will incur a \$15 per unit transportation surcharge up to 96”.

Oversized: In addition to the transportation surcharge, a \$45 per unit Common Carrier surcharge will be added to all fabricated products shipping within the Continental US, including shades/blinds, Vertical Sheer Shadings, Ovation Cellular Slider, Envision Panel Track system, valances, vane packs, individual vanes, tracks, and cut yardage orders with widths of over 96 inches.

Hawaii: Shipments to Hawaii will incur a freight charge of \$26.00 per unit when shipped from within the Continental US. In Addition, a \$132.00 per unit Common Carrier surcharge for oversized shades/blinds (over 96”) will be added to orders shipping to Hawaii.

Alaska: Shipments to Alaska will incur a \$26.00 per unit transportation surcharge when shipped from within the Continental US. In addition, a \$132.00 per unit Common Carrier surcharge for oversized shades/blinds (over 96”) will be added to orders shipping to Alaska from within the Continental US.

Canada: Shipments to Canadian Dealers will incur a \$7.75 per unit transportation surcharge when shipped from within the Continental US. In addition, a \$75.00 per unit Common Carrier surcharge for oversized shades/blinds (over 96”) will be added to orders shipping to Canada from within the Continental US.

Other Countries: All US Dealers requesting to ship orders outside the USA, must provide a Freight Forwarder for Comfortex to ship to within the Continental US. Comfortex cannot ship directly to your customers located outside USA.

Components and Fabric

Comfortex will prepay all freight charges on shipments of component and fabric orders over \$3,500 in value within the Continental US. Fabric and component orders less than \$3,500 will be subject to freight charges.

Shutter Components and Tools

Comfortex will prepay all freight charges on shipments of stock component and tool orders exceeding \$20,000 in value, within the Continental US only. All orders less than \$20,000 will be subject to all freight charges. Customers can elect a carrier of choice and receive a freight bill directly from the carrier or Comfortex will select a carrier and invoice the customer for the freight charges. Comfortex makes every effort to provide the most economical carrier and shipping method possible.

Charged Marketing Materials

All charged marketing materials will incur freight charges. Marketing materials may ship on separate days, from different locations. Freight charges are calculated per package, not per order.

Specifications

All Comfortex products are designed and tested to perform as intended within established, published parameters. Requests for “custom fabrication” of products outside of our published specifications may be considered, but are at the discretion of the Comfortex Technical Services department. Restrictions and additional charges apply.

Download installation instructions, order forms or additional price list copies on the Comfortex OnDemand Library or www.comfortex.com/comfortex-dealers in the Dealers Resource Center.

Cellular Shade Collection
GENERAL INFORMATION

⚠️ WARNING

⚠️ ADVERTENCIA

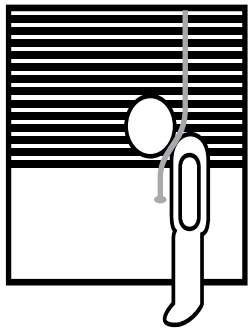

Window Blind Cord Can STRANGLE Your Child.

To prevent strangulation, purchase cordless products or products with inaccessible cords.

La cuerda ciega de la ventana puede ESTRANGULAR su niño.

Para evitar el estrangulamiento, compre alternativas inalámbricas o productos con cables inaccesibles.

Child Safety

Comfortex has a long history of designing new child-safety products and is proud to provide a leadership role in cooperating with the Consumer Product Safety Commission (CPSC) for the development of policies and guidelines for the industry by serving on the WCMA Standards Development Committee.

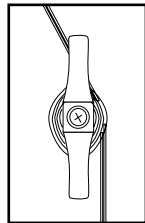

Cord Cleat

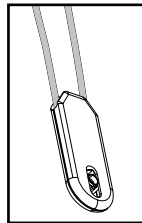

Cord Tensioner

All Comfortex products have been fully tested and proven to comply with the current WCMA Standards for safety of corded window coverings.

Be aware that it is possible for children to become entangled in window covering cords. To reduce the risk of accidents, all cords must be kept out of the reach of children.

A cord cleat or cord tensioner is an effective way to implement this essential precaution. Please use them.

To mount the cord cleat at a safe height, take into account furniture or other objects upon which a child may climb. Then, after the use of the blind, simply wrap the excess cord around the cleat.

Cellular Shade Collection
GENERAL INFORMATION

GENERAL INFORMATION

Cellular, Pleated and Prelude Shades
Odysee Cellular Blinds Warranty Information

Comfortex warrants that its window treatments will be free from defects in materials and workmanship for as long as the original residential purchaser owns the product, provided that the product was installed properly and in accordance with the installation instructions. The Limited Lifetime Warranty is extended to the original residential purchaser only, in the original window for which it was installed.

The Warranty does not include any conditions or damages resulting from accidents, alterations, misuse, abuse, misapplication, improper handling, installation, repairs, operation, cleaning, exposure to any and all natural and manufactured excessive heat sources. (Excessive heat sources include, but not limited to; magnification of sun light through cubes of glass, heaters of any kind, ovens, candles, lighting fixtures, etc.) This warranty does not cover variation in fabric color, grain, or texture in natural wood products nor excessive warping of wood slats in high humidity areas. Loss of pleating is not covered if the product is not being cycled (held in the raised position a portion of the time). Normal wear and tear is not covered.

All moving parts, such as cords and strings (internal and external), will eventually wear out and fabric may fray. Comfortex considers these things as normal wear and tear and will carry a five year Limited Warranty. All fabric, including fabric vanes, panels, inserts, and shades carry a five year Warranty. Fabric cell separation is covered for a lifetime. See Comfortex Standard Return and Repair Policy for more details.

This Limited Warranty does not cover transportation costs to and from the retailer, costs of removal, re-measure, reinstallation of product, or any incidental or consequential damages.

If a Comfortex product is found to be defective in materials or workmanship, we will, at our discretion, repair, replace or refund the cost of a product which fails to conform to this Limited Warranty. Colors vary from lot to lot and may not exactly match sample swatch, sample book, or previous purchases. Discontinued components or color selections will be replaced with the closest equivalent current product. This shall be your sole remedy under this Limited Warranty.

To obtain service, contact the Dealer from whom you purchased the product.

This Warranty is exclusive and in lieu of all other obligations, liabilities or warranties. In no event shall Comfortex or its licensed fabricators or distributors be liable for incidental or consequential damages, or for any other damage, loss or expense, cost or fee associated with such damage. In some

states, exclusions for incidental or consequential damages are not allowable. Comfortex Dealers and Fabricators must use safety devices supplied by Comfortex in accordance with Window Covering Safety Counsel guidelines.

This Warranty gives you specific legal rights, and you may also have other rights, which vary from state to state. Policy is subject to change without notice.

This Limited Warranty is exclusive of commercial use. Contact Comfortex Technical Service for more information. No agent, representative, dealer or unauthorized employee has the authority to increase or alter the obligation of this Warranty.

This Limited Warranty supersedes any previous versions.

Motorized Cellular and Pleated Shades and Odysee Cellular Blinds Warranty

PowerTouch and Rechargeable Simplicity Motorization

We offer a 5 year warranty on all motors and controls. Specifically, we warrant the Simplicity motors and controls to be free from defects in material and workmanship under normal and proper use for a period of 5 years commencing with the date stamped on each product. If the Simplicity product fails within this 5 year period, we will repair or replace it free of charge through your end product supplier.

Custom Graphics Cellular Shades Color Warranty

Comfortex utilizes state of the art technology to provide you Custom Graphics Shades within 2 Delta-E (DE) of the sample fabrics found in the Comfortex Collections Cellular and Pleated Sample Book. When viewed under different lighting sources such as fluorescent, incandescent, halogen, ultraviolet and others, fabrics may appear different to the eye. Comfortex utilizes the worldwide lighting standards of Daylight 65 (D65) as our official standard for measuring and qualifying color accuracy, because D65 daylight bulbs best represent actual "daylight" illumination. Slight color variations (under 2 DE) are within established industry standard and should be expected.

This warranty is in addition to Comfortex limited lifetime warranty.

Cellular Shade Collection

GENERAL INFORMATION

Scotchgard™ Warranty

Comfortex Window Fashions provides a limited warranty for fabrics treated with Scotchgard™ Protector against permanent stains for a period of 1 year from the date of original purchase.

This warranty excludes conditions or damages resulting from accidents, alterations, exposure to the elements, and exposure to any and all natural and manufactured excessive heat sources, or failure to follow the Installation and Care instructions. This warranty also excludes fabric submerged in water or cleaning solutions, or treated with household products that may alter or deplete the effectiveness of the treated fabric. In addition, the following types of stains are excluded from this limited warranty: pet stains, bodily fluids, stains caused by wine, bleach, plant fertilizers, acne medication, misuse or abuse. This warranty is not a cleaning contract and does not cover the cleaning of fabrics that are soiled or discolored through daily use. This warranty coverage is limited to residential use and is not transferable.

The following are the recommended cleaning and care instructions for window treatments with fabric treated with Scotchgard™ Protector.

- Gently blot liquid stains immediately with a clean, white cloth.
- If stain remains, prepare a solution of ¼ teaspoon of clear, non-bleaching dish detergent mixed with 1 cup of lukewarm water. Dampen a clean white cloth and gently blot the stain.
- Do not overwet the fabric or excessively rub the stained area.
- See the Installation and Care instructions for complete details.

For additional assistance with stain removal, call the Scotchgard™ Protector Service Center at 1-800-433-3296. Customer Care representatives are available Monday through Friday, 8am to 6pm CT.

Should the results of the cleaning and care instructions not result in the removal of permanent stains covered by this limited warranty, Comfortex will retreat or replace the fabric, at its discretion, for a period of 1 year from the date of original purchase. Customer must provide proof of purchase and provide proof the stain occurred during the warranty period. Shipping and handling costs to send the window treatment back to Comfortex are the responsibility of the customer.

This warranty gives you specific legal rights, and you may also have other rights which vary from state to state.

©2019 COMFORTEX CORPORATION

™ is a trademark of Comfortex Corporation. ® is a registered trademark of Comfortex Corporation. The GREENGUARD INDOOR AIR QUALITY CERTIFIED Mark is a registered certification mark used under license through the GREENGUARD Environmental Institute. GREENGUARD Children & SchoolsSM is a service mark used under license through the GREENGUARD Environmental Institute. Energizer® is a registered trademark of Energizer Holdings, Inc. Symphony® and Soprano® are registered trademarks of Comfortex Corporation. Symphony® is covered by U.S. Patent Nos. 5,193,601 and 4,974,656 respectively. Ovation™ Cellular Slider is covered by one or more of the following U.S. Patent Nos.: 4,862,941, 4,858,668, 4,915,153, D346,032, D324,108, 4,450,027, 4,631,108, 4,603,072, 5,690,778, 5,664,773, 6,319,586, 5,482,750, 5,601,885 and 4,631,217. SlumberShade™ is covered by U.S. Patent No. 8,371,355. Karma-Light™, PowerTouch™, Timeless Textures™, Debut™, Cordless Ultra™, Sunset™, Balcony™ and Ovation™ are trademarks of Comfortex Corporation. Other U.S. and foreign patents pending. All rights reserved.

Odyssey is covered by U.S. Patent Nos. 5918655, 4372432, 4433765, 4623012, 5697630, 5058720, 5228491, 5375643, 5733632 and 5680891. Additional U. S. and foreign patents pending.



Midwest
Designer
Supply

1-888-523-2611

**Midwest Designer Supply, Inc.
N30W22377 Green Road Ste C
Waukesha, WI 53186
(262) 523-2600
Fax (262) 524-1007
www.midwestdesignersupply.com**

MDS - your one source for window fashions.